

EGO™

POWER BEYOND BELIEF™

PRODUCT CATALOGUE 2023



ZERO
EMISSION



CONTENTS

04	Introduction	46	EGO Power+ Chainsaws
06	EGO Power+ Battery Technology	52	EGO Power+ Professional-X Top Handle Chainsaw
08	The EGO Power+ System	54	EGO Power+ Professional-X Telescopic Pole System
10	The EGO Power+ Warranties	58	EGO Power+ Line Trimmers & Brush Cutter
12	EGO Power+ New for 2023	65	EGO Power+ Professional-X Rotocut
14	The EGO Power+ Tool Categories	66	EGO Power+ Professional-X Line Trimmers / Brush Cutters
16	EGO Power+ Professional-X Range	70	EGO Power+ Hedge Trimmers
20	EGO Power+ Batteries & Chargers	80	EGO Power+ Blowers
22	EGO Power+ Batteries	88	EGO Power+ Snow Throwers
24	EGO Power+ Harness & Adapter	92	EGO Power+ Multi-Tool
26	EGO Power+ Chargers	104	EGO Power+ Lifestyle
29	EGO Power+ Multi-Port Charging Case	110	A Greener Future
30	Battery Compatibility & Runtimes	112	EGO Power+ Accessories
32	EGO Power+ Mowers	116	EGO Power+ Product Features
40	EGO Power+ Z6 Zero-turn Ride-on Mower		

LEADING EUROPE TO A BATTERY POWERED FUTURE

Our unique patented 56V ARC Lithium™ batteries are designed to maximise performance. Boasting the outdoor tool industry's highest energy capacity in a portable battery, they last longer and charge quickly. Each battery is interchangeable across the entire EGO cordless range – delivering optimum power and performance for every tool and every job.

Batteries designed to be better.

Our battery's unique ARC-shaped design and KeepCool™ Technology work together to lower temperature and prevent overheating and shutdowns. Each battery's intelligent power management system works hand-in-hand with all tools to ensure the very best power, performance and run time. EGO's superior battery technology really does deliver power beyond belief.

Experts in battery technology.

Our industry-leading innovation stems from a talented team of over 400 highly qualified technicians. Their expertise is the driving force behind our future-focused research and development, and our award-winning range of outdoor cordless products.

Experts in tool technology.

Our dedication to innovation doesn't stop with our battery. We listen to our users and have developed world-first patented tool technologies that answer some of the biggest user pain points in the industry, such as Line IQ™ Technology, Peak Power™ Performance and Powerload™ Technology.

SMARTER, GREENER WAYS TO WORK OUTDOORS

At EGO, we think beyond performance. Our experts are relentless in their drive to innovate tools for a better world. EGO's 56V ARC Lithium™ batteries not only outperform fuel, they are better for the environment.

Petrol-powered outdoor tools produce more nitric oxide, nitrogen dioxide and carbon dioxide than car engines. With zero toxic emissions in use, EGO power tools are cleaner, quieter, and safer. Without the need for fossil fuel, they are also cheaper to run and maintain. Our cordless tools are designed with smart features that pose no risk to users' health and are comfortable to use for prolonged periods.

Influencing change through innovation.

We're a leading manufacturer working at the forefront of transformative technology, yet our desire to create a greener future isn't limited to the products we develop. It pervades the ways we operate and the places we work, as well as the relationships we have with our customers and partners. Read more about our Challenge2025 initiative on page 110.

Our results speak for themselves. **97% of EGO customers** recommend our products and our average product rating is **4.6 out of 5 stars**.*

* Correct at time of going to press



A BATTERY DESIGNED LIKE NO OTHER

EGO's unique patented 56V ARC Lithium™ battery delivers the industry's highest energy capacity.

Our team of experts has revolutionised battery technology to deliver the optimum power and performance for outdoor cordless tools. EGO's 56V batteries deliver more usable power than any other portable battery. The eight batteries in our range can be used flexibly with each one of our cordless tools.

Key to its performance is the battery's intelligent design.

The innovative ARC shape of our 56V battery increases surface area, placing the battery cells close to the surface to maximise cooling and prevent overheating. Each battery cell is surrounded by EGO's unique KeepCool™ Technology, designed to absorb heat energy and keep the cells at their optimum temperature for longer run times. Software and microprocessors monitor and optimise each cell to deliver the best power and performance for every job.

Super fast recharge.

Our commitment to innovation not only delivers the industry's highest energy capacity in a portable battery. It also means that when it's time to recharge, the EGO Power+ 56V ARC Lithium™ battery is one of the quickest around.



For more information on how EGO Power+ batteries work, and what makes them so revolutionary, download the Battery FAQ document on our website.

egopowerplus.co.uk/FAQdownload

EGO POWER+ ARC LITHIUM™ BATTERY, DESIGNED TO MAXIMISE PERFORMANCE

The patented 56V ARC Lithium™ battery doesn't just manage heat, it maximises cooling.

A battery gets hotter the longer it's used. The more power it generates, the more heat is released. Too much heat and the battery will shut down for safety. Heat also degrades cells over time, reducing battery life. That's why batteries must be cooled effectively to increase performance, run time and battery life.

Our batteries have been designed to cool effectively in three innovative ways: mechanically, chemically and electronically.

Unique ARC design.

Unlike conventional brick-shaped batteries where the cells are packed together, the ARC shaped design increases surface area, places the cells close to the surface and fits onto the outside of EGO tools. This dissipates heat more effectively, preventing overheating and shut-downs.

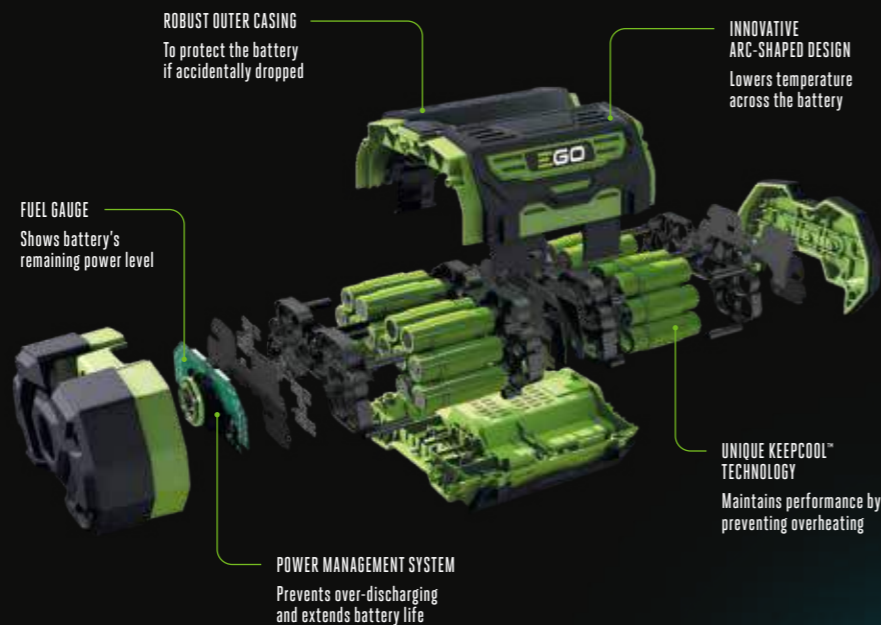
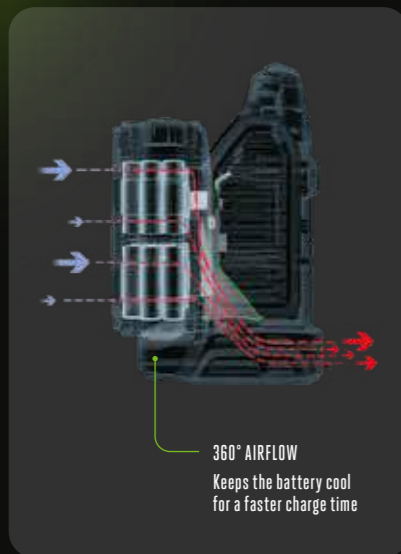

INCREASED SURFACE AREA

The battery ARC shape has been carefully designed to optimise cooling and reduce overheating. Unlike "brick shaped" batteries, the individual battery cells are positioned adjacent to the external housing so heat can be easily transferred away from the cells.



KEEPCOOL™ TECHNOLOGY

It's not just the innovative ARC design that helps prevent overheating. The battery has another clever way to keep cool. Each and every cell is surrounded by our unique KeepCool™ phase change material that absorbs heat energy and keeps individual cells at their optimum temperature for longer run times.



INTELLIGENT POWER

Power is nothing without control. It's why the EGO Power+ 56V ARC Lithium™ battery is continuously controlled by software and microprocessors within the battery and by the tools' intelligent power management systems. These constantly monitor and optimise each individual cell, to deliver the very best power, performance and run time.



EXTERIOR MOUNTED BATTERY

Unlike other manufacturers, EGO batteries fit onto the outside of the tools and are not encased within the tool, which means they stay cool to deliver longer lasting power. To keep them safe and sound, the electronics are protected from dust and moisture by a resin coating and the cells are packaged in a robust case that absorbs shocks and vibrations.

ANY BATTERY, ANY TOOL

Our industry-leading 56V ARC Lithium™ batteries work with all EGO Power+ tools, even our Professional-X range. With great performance and long run times, simply select your tool, click in and go.



EGO POWER+
MOWERS

EGO POWER+
HEDGE
TRIMMERS

EGO POWER+
TELESCOPIC
POLE SAW



EGO POWER+
Z6 ZERO-TURN
RIDE-ON MOWERS



EGO POWER+
BLOWERS



EGO POWER+
SNOW THROWERS



EGO POWER+
LIFESTYLE



EGO POWER+
LINE TRIMMERS
& BRUSH CUTTERS



EGO POWER+
CHAINSAWS

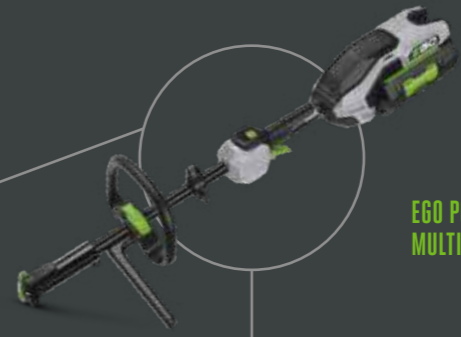

EGO POWER+
MULTI-TOOL



HEDGE TRIMMERS

POLE SAW

LINE TRIMMERS

BRUSH CUTTER

ROTOCUT

EDGER

CULTIVATOR

BRUSHES

OLIVE SHAKER

SNOW SHOVEL



EGO POWER+
PROFESSIONAL-X
BACKPACK HARNESS



EGO POWER+
PROFESSIONAL-X
BATTERY HOLSTER



EGO POWER+
PROFESSIONAL-X
TOP HANDLE CHAINSAW

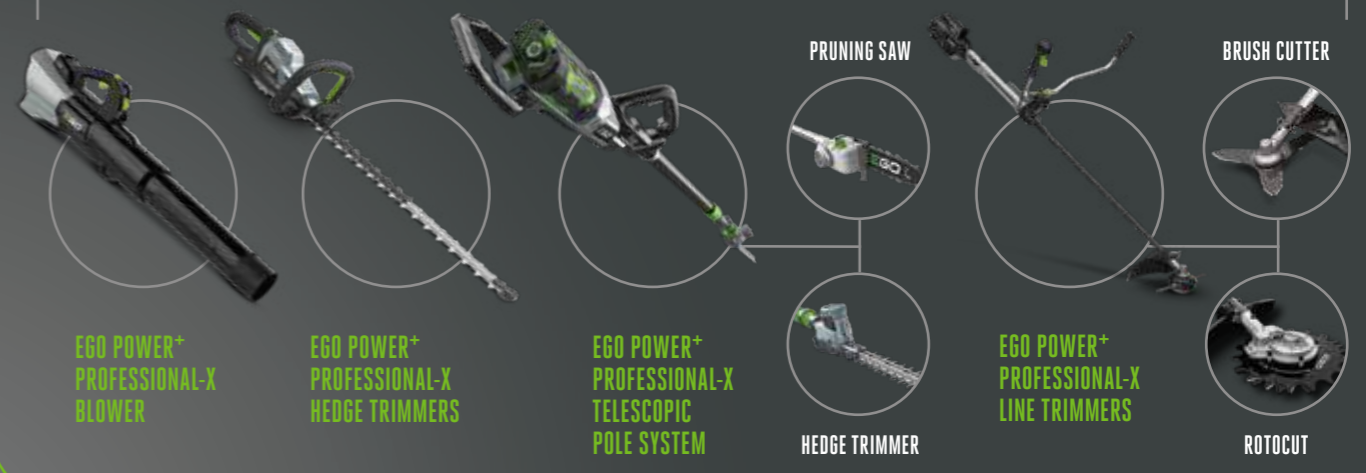

EGO POWER+
PROFESSIONAL-X
BLOWER

EGO POWER+
PROFESSIONAL-X
HEDGE TRIMMERS

EGO POWER+
PROFESSIONAL-X
TELESCOPIC
POLE SYSTEM

HEDGE TRIMMER

PRUNING SAW

EGO POWER+
PROFESSIONAL-X
LINE TRIMMERS

BRUSH CUTTER

ROTOCUT

THE POWER TO OUTPERFORM PETROL

Introducing the innovative EGO Power+ system from the cordless specialists. EGO Power+ delivers petrol-matching power without noise, fuss, or emissions.

Our industry-leading 56V ARC Lithium™ battery technology offers a new level of performance, giving you the power you need to keep working hard until the job's done. With impressive run times and fast recharge, there's no need to purchase or store highly flammable fuel. Instead, you get the freedom to work emission-free. For total flexibility, all of EGO's 56V ARC Lithium™ batteries fit every tool in the EGO Power+ 56V range.* Just click in the battery and you're ready to go. When you try this revolutionary cordless system you'll never look back.

The support of our service dealer network.

EGO approved service dealers can help you select the most suitable tools for your needs, give you face-to-face advice and provide a diagnostic service to keep your tools running for years to come. With a nationwide network of EGO approved service dealers, you're never too far from the support you need.



Industry-leading warranties.

Domestic user

For domestic users we offer a 5-year warranty on all tools and a 3-year warranty on batteries, when registered within 30 days of purchase.**

Professional user

We offer professional users a 3-year warranty on the Professional-X range, and a 2-year warranty on the Professional range when tools are registered within 30 days of purchase.**

	TOOLS		BATTERIES	
	DOMESTIC USE	PROFESSIONAL USE	DOMESTIC USE	PROFESSIONAL USE
	5 YEAR TOOL WARRANTY	1 YEAR TOOL WARRANTY	3 YEAR BATTERY WARRANTY	
	5 YEAR TOOL WARRANTY	2 YEAR TOOL WARRANTY	3 YEAR BATTERY WARRANTY	2 YEAR BATTERY WARRANTY
	5 YEAR TOOL WARRANTY	3 YEAR TOOL WARRANTY	3 YEAR BATTERY WARRANTY	3 YEAR BATTERY WARRANTY

* 12V Shrub Shears are not compatible with ARC Lithium™ 56V battery system.

** For defects caused by material or manufacturing fault. This does not cover wear and tear. Full terms and conditions are available on our website.

SWITCH TODAY

The EGO Power+ system outperforms petrol without any of the downsides. It's simpler, cleaner, quieter - and with less vibrations, more comfortable to use. Lower running and maintenance costs means switching to EGO Power+ leads to long-term savings too. Its cutting-edge battery technology delivers optimum power and performance for every tool and for every job. Plus, with zero emissions during use, it reduces your impact on the environment.



WHY CHANGE FROM PETROL TO EGO POWER+?



SUPERIOR BATTERY TECHNOLOGY

Our industry-leading 56V ARC Lithium™ batteries deliver intelligent, balanced power that outperforms petrol



LOWER RUNNING COSTS

The cost of running an EGO Power+ product for a month is around the same as using a 2 stroke product for a day*



BETTER FOR THE ENVIRONMENT

With zero emissions during use, our 56V ARC Lithium™ battery gives petrol-matching power but without the fuss and fumes



FOLD FLAT, EASY STORE DESIGN

Unlike large, heavy petrol mowers, the EGO Power+ fold-flat design makes storage, cleaning and transportation simple



BETTER FOR YOUR HEALTH

EGO Power+ tools always operate at lower noise and vibration levels than traditional petrol-powered tools



SAVE TIME

No more trips to the petrol station. EGO's rapid charger refuels our intelligent batteries in as little as 30 minutes



EASY SET-UP AND STARTING

No filling up with fuel; with EGO Power+ just click in the battery and get to work



NO PETROL TO STORE

No more dangerous fuel in storage, no more fumes, make more space available for other things

*Based on average daily use of 3 litres of post mix fuel per day.

NEW FOR 2023

**OUR LATEST
INNOVATIONS**

The 2023 range pushes the boundaries of innovation, with an expanding ride-on mower and brand-new lifestyle categories.

Each new product has EGO's unrivalled ARC Lithium™ Technology at its core, giving you the power to tackle even bigger and tougher tasks with the same impressive run times and rapid recharge as always.



ZT4200E-S
Z6 ZERO TURN MOWER WITH E-STEER™ TECHNOLOGY
P43



ZT5200E-L
Z6 ZERO TURN RIDING MOWER
P44



STA1600
LINE TRIMMER ATTACHMENT
P101

PH1420E
MULTI-TOOL POWERHEAD
P96



PAD5000E
500W NEXUS ESCAPE POWER INVERTER
P107



LT1000E
PORTABLE AREA LIGHT
P109

BA3360T
6AH BATTERY
P22



CH7000E
700W RAPID+ CHARGER
P26



CH3200E
320W QUICK CHARGER
P26



HT2600E
HEDGE TRIMMER
P74



PS1000E
POLE SAW
P53

ST1610E-T
40CM LINE TRIMMER
P60



FN1800E
MISTING FAN
P108



SNT2120E-AP
SNOW THROWER
P90



LBP8000E
BACKPACK BLOWER
P86

CHOOSE THE RIGHT TOOL FOR ANY TASK

EGO's range of outdoor power equipment is designed to deliver an outstanding level of performance for every outdoor job, providing the right balance of power and usability for domestic, professional and specialist users.

EGO's unique ARC Lithium™ cordless technology combines with best-in-class ergonomic design to deliver maximum power and efficiency for working outdoors.

Work smarter. Work healthier.

Any EGO battery will fit any EGO tool (see pages 8-9), so you can choose the right combination to suit your challenge:

- Range of 8 batteries and 1 backpack battery available, so you can choose the optimum power-to-weight ratio for any task.
- Belt and back harness-mounted options for lighter working.
- Backpack battery options for the most demanding jobs in all weathers.

EGO outdoor power equipment allows you to work in a cleaner, quieter and safer way. EGO delivers the power of petrol, without the emissions, noise and vibration associated with petrol-powered products - better for you and better for the environment.

The best battery power, from the cordless specialists.



PETROL-MATCHING PERFORMANCE FOR DOMESTIC GARDENS



A complete range of cordless outdoor power tools, ideal for regular domestic use.

EGO Power+ tools are designed for regular use in domestic gardens. EGO Power+ tools gives domestic users, cordless, petrol-matching power without the noise, fuss or emissions. With EGO's outstanding level of performance built-in as standard - tackle every garden maintenance task with ease.



PROFESSIONAL

HARD-WEARING TOOLS FOR LARGE GARDENS AND PROFESSIONAL USE



A range designed for heavy-duty use, perfect for large garden maintenance and landscaping professionals.

Ideal for everyday use, the EGO Power+ Professional range gives you the edge when facing tougher tasks for longer periods. This range includes additional features, designed to make light work of larger garden maintenance tasks. Whether working in a large garden or tackling commercial jobs, you can rely on EGO Power+ Professional tools to be powerful, hard-wearing and robust.



PROFESSIONAL X

SUPER-TOUGH, SUPER-POWERFUL RANGE FOR PROFESSIONAL AND SPECIALIST USE



A super-tough, super-powerful range of tools designed for garden maintenance professionals, facilities management and specialists.

The EGO Power+ Professional-X range is engineered to work harder, all day, every day, in the most challenging conditions. Ergonomic design meets unrivalled power and performance in the Professional-X range. These tools push the boundaries of battery technology, with the power and performance to surpass petrol-powered equivalents. Built to last, the Professional-X range delivers clean, quiet, safe and productive working.



MINIMAL VIBRATION, NOISE AND COST

EGO tools deliver all the power of petrol tools without the physical stresses, noise and vibration.

Choosing EGO's low-vibration cordless tools helps to avoid the risk of Hand-Arm Vibration Syndrome (HAVS). Also known as 'Vibration White Finger', it can cause painful and disabling disorders of the blood vessels, nerves and joints.

Comfortable for all day use.

With a smooth brushless motor and fewer moving parts, all EGO tools have been designed to operate with low levels of vibration, often under the 2.5m/s² Exposure Action Value limit (EAV) and well below the Exposure Limit Value (ELV). This allows users to work comfortably all day.

Quieter working conditions.



Daily exposure to noisy petrol tools can lead to increased work-related stress, hearing loss and Tinnitus – a permanent ringing sensation in the ears. EGO tools are much quieter than petrol-powered alternatives and reduce the risk of increased stress levels and potential hearing loss over long-term use.

AIR SPEED: 212km/h

FORCE: 19.2N

PETROL VS. EGO POWER+

Based on a customer purchasing three tools from the Professional-X range – the HTX7500 hedge trimmer, STX3800 line trimmer and LBX6000 leaf blower, plus the backpack harness and rapid charger to run all three tools, and petrol-powered equivalent tools and fuel.

PETROL		PROFESSIONAL-X RANGE	
INITIAL OUTLAY YEAR 1			
	TOOLS 2.240.00 €		TOOLS 1.267.00 €
	SERVICING 359.99 €		BATTERIES & CHARGERS 1.286.00 €
	FUEL 1.069.16 €		ELECTRICITY 62.91 €
COST YEAR 1	3.309.16 € <small>Inc purchase of tools</small>	2.615.91 € <small>Inc purchase of tools</small>	693.25 € <small>Year 1 saving</small>
COST YEAR 2	1.506.13 € <small>Fuel and servicing</small>	64.15 € <small>Recharge cost only</small>	1.441.98 € <small>Year 2 saving</small>
COST YEAR 3	1.588.65 € <small>Fuel and servicing</small>	65.42 € <small>Recharge cost only</small>	1.523.23 € <small>Year 3 saving</small>
COST YEAR 4	1.677.11 € <small>Fuel and servicing</small>	66.71 € <small>Recharge cost only</small>	1.610.40 € <small>Year 4 saving</small>
COST YEAR 5	1.771.94 € <small>Fuel and servicing</small>	68.02 € <small>Recharge cost only</small>	1.703.92 € <small>Year 5 saving</small>
TOTAL COST OF OWNERSHIP	9.852.99 €	2.880.21 €	SAVING AT YEAR 5 BY INVESTING IN CORDLESS 6.972.78 €

• Cost Estimates are based on purchasing HTX7500 hedge trimmer, STX3800 line trimmer and LBX6000 leaf blower, plus the 2x 10Ah batteries and rapid+ charger to run all three tools, and petrol-powered equivalent tools and fuel.
• Fuel consumption - running these machines for 6 hours a day for 170 days a year.

TOUGH TOOLS FOR THE TOUGHEST TASKS

The EGO Professional-X range redefines cordless tools. Delivering industry-leading power and performance, each tool exceeds their petrol-powered equivalent. Every Professional-X tool is compatible with all battery options, offering ultimate flexibility to complete any job of any size.

2.5AH BATTERY, 140WH, 1P



4AH BATTERY, 224WH, 1P



4AH BATTERY, 224WH, 2P



5AH BATTERY, 280WH, 2P



6AH BATTERY, 336WH, 3P



7.5AH BATTERY, 420WH, 3P



10AH BATTERY, 560WH, 4P



12AH BATTERY, 672WH, 4P



EGO POWER+ PROFESSIONAL-X
BACKPACK BATTERY 1568WH



EGO POWER+ PROFESSIONAL-X
BACKPACK HARNESS



EGO POWER+ PROFESSIONAL-X
BATTERY HOLSTER



EGO POWER+
PROFESSIONAL-X
BLOWER



EGO POWER+
PROFESSIONAL-X
HEDGE TRIMMERS



EGO POWER+
PROFESSIONAL-X
TELESCOPIC POLE



EGO POWER+
PROFESSIONAL-X
LINE TRIMMERS/
BRUSH CUTTERS



PRUNING SAW

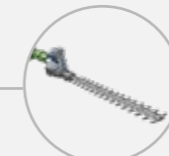

HEDGE TRIMMER



BRUSH CUTTER



ROTCUT



EGO POWER+
PROFESSIONAL-X
TOP HANDLE CHAINSAW

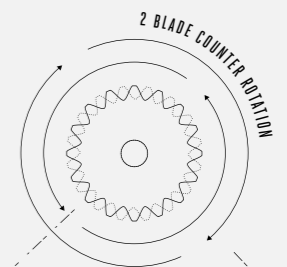

2 BLADE COUNTER ROTATION

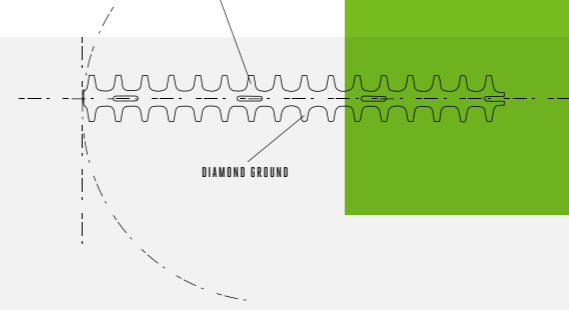

DIAMOND GROUND

EGO[™]
POWER⁺ BATTERY & CHARGER

WITH THE CAPABILITY TO OUTPERFORM PETROL,
OUR INNOVATIVE RANGE OF BATTERIES AND
CHARGERS DELIVER ALL THE POWER YOU NEED.





For more information on how EGO Power+ batteries work, and what makes them so revolutionary, download the Battery FAQ document on our website.

egopowerplus.co.uk/FAQdownload



BA1400T
2.5AH BATTERY 140WH, 1P

THE RIGHT POWER FOR EVERY JOB

EGO Power+ 56V ARC Lithium™ batteries.

From the lightest 2.5Ah to the largest 12Ah in the range, as the batteries go up in size, so does the power capacity and run time. Whichever model you choose, they have all been engineered for optimal performance and designed to fit all EGO tools*.

NEW FOR 2023

BA3360T
6AH BATTERY 336WH, 3P

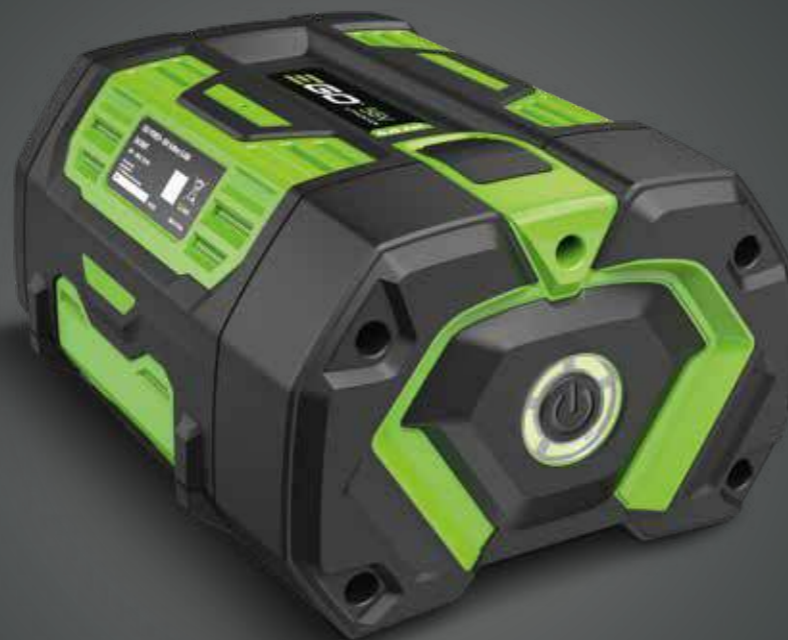

BA2240T
4AH BATTERY 224WH, 1P



BA2242T
4AH BATTERY 224WH, 2P



BA2800T
5AH BATTERY 280WH, 2P



BA4200T
7.5AH BATTERY 420WH, 3P



BA5600T
10AH BATTERY 560WH, 4P



BA6720T
12AH BATTERY 672WH, 4P

* For portable handheld batteries.
12V Shrub Shears not compatible with ARC Lithium™ 56V battery system.

COMFORTABLE ALL-DAY USE

The ergonomic EGO Power+ backpack harnesses and battery holster are the most comfortable way to enjoy EGO's industry-leading power. They evenly distribute weight for an easier, more comfortable way to work.



Image shown as a kit BH1001



BH1000 BACKPACK HARNESS

The BH1000 is ideal for taking the weight of the battery from your arms. This provides greater stability and comfort especially when using our larger batteries over prolonged periods.



BHX1000 PROFESSIONAL-X BACKPACK HARNESS

The BHX1000 has been designed with the professional user in mind and when used together with the AFH1500 harness (supplied separately or as part of a kit) provides exceptional comfort for all day use. The BHX1000 is compatible with the Professional-X series and with the ADB1000 adapter can be used with other EGO tools. The AFH1500 Harness (supplied separately) is compatible with the BHX1000 and the BAX1500 Professional-X backpack battery.



ABH3000 PROFESSIONAL-X BATTERY HOLSTER, CABLE AND ARBORIST'S STROP

The holster is designed to house the EGO battery, which is perfectly matched for use with the EGO Power+ Professional-X Top Handle Chainsaw to deliver optimal torque and power for professional arborists. The safety-strop attachment integrates with the battery cable and belt or harness to keep you and your team safe in the trees.

ADVANCED COMFORT FOR ULTIMATE PRODUCTIVITY

Team up your EGO Power+ tools with our backpack battery.

Balancing exceptional run time with user comfort, the ergonomic design of EGO's ARC Lithium™ BAX1500 backpack keeps you working comfortably all day long. The battery pack can be removed from the harness and is compatible with all EGO tools.

Designed to perform, built to last.

The EGO Power+ Backpack Battery can last throughout a full day's work* from a single charge. The high-quality cells, with high power rating and high energy density, can handle over 1,000 charge cycles. Plus, rapid recharging means they can go from empty to full in just 3.5 hours.



BAX1500 PROFESSIONAL-X BACKPACK BATTERY



The EGO Power+ Professional-X backpack battery delivers the power output and run times needed for demanding jobs. All minus the noise, emissions and vibration. The BAX1500 can work through the most extreme weathers and its tough casing is designed to withstand any drops or knocks.

	BAX1500
CAPACITY	1568Wh at 56V rated
CONNECTION METHOD	Adapter / Plug-in
BATTERY WEIGHT	9.0kg w/o harness
HARNESS	Supplied separately or as part of a kit
WEATHERPROOF PROTECTION	IP56
CHARGER	CHX5500E
CYCLE LIFE	In excess of 1000 cycles
DOMESTIC WARRANTY	3 years
PROFESSIONAL WARRANTY	3 years
AVAILABLE AS A KIT	BAX1501: Includes backpack battery, harness and adapter

BIG POWER, BIG BENEFITS

COMPATIBLE WITH EVERY
EGO POWER+ TOOL

HIGH-EFFICIENCY
BATTERY LIFE

DETACHABLE BATTERY
AND HARNESS

WORK HEALTHIER

Without strains, musculoskeletal problems, or emissions.

COST EFFECTIVE

Purchasing and running the Professional-X Hedge Trimmer, Line Trimmer and Leaf Blower will save you over 6.000 € in 5 years, compared with their petrol-powered equivalents. Costs estimated on run times of 6 hours a day, 170 days a year.

*Dependent on the tool and based on an 8 hour working day.

MARKET-LEADING CHARGING TIMES

When it comes to recharging our range of batteries, the EGO Power+ charger keeps you working for longer. Charging 2.5Ah batteries in under 30 minutes, the new CH7000E reduces charging times so that you can get back to the task in hand.

The innovative fan-cooled system allows charging to start sooner and finish faster, while the intelligent battery control system constantly monitors each cell's power and temperature to deliver the most efficient and quickest charge.



NEW FOR 2023

**CH7000E
700W RAPID+ CHARGER**

Boasting an impressive charge time of under 30 minutes for the 2.5Ah battery, this charger features an integrated LED charging indicator and an intelligent battery control system. This fan-cooled charger provides the most efficient charge possible.

NEW FOR 2023

**CH3200E
320W QUICK CHARGER**

Charging the 2.5Ah battery in just 35 minutes, our light-weight charger is among the fastest on the market. This fan-cooled charger, equipped with an intelligent battery control system is complete with an integrated LED charging indicator for clear battery diagnostics.



**CH5500E
RAPID CHARGER**



**CH2100E
STANDARD CHARGER**



**CHX5500E
PROFESSIONAL-X CHARGER**

PERFORMANCE STATISTICS									
BATTERY MODEL	BA1400T	BA2240T/ BA2242T	BA2800T	BA3360T	BA4200T	BA5600T	BA6720T	BAX1500	
BATTERY (Ah)	2.5Ah	4.0Ah	5.0Ah	6.0Ah	7.5Ah	10.0Ah	12.0Ah	28.0Ah	
CAPACITY (Wh)	140	224	280	336	420	560	672	1568Wh at 56V rated	
CHARGE TIMES	RAPID CHARGER: CH5500E	30 mins	30 mins	40 mins	45 mins	60 mins	70 mins	80 mins	210 mins
	STANDARD CHARGER: CH2100E	50 mins	80 mins	100 mins	120 mins	145 mins	190 mins	220 mins	-
	PROFESSIONAL-X CHARGER: CHX5500E	-	-	-	-	-	-	-	Default: 420 mins Rapid: 210 mins
	320W QUICK CHARGER: CH3200E	35 mins	55 mins	70 mins	80 mins	100 mins	130 mins	160 mins	-
700W RAPID+ CHARGER: CH7000E	<30 mins	<30 mins	30 mins	35 mins	45 mins	60 mins	75 mins	-	
WEIGHT	1.2kg	1.9kg/2.2kg	2.2kg	2.6kg	2.8kg	3.4kg	3.6kg	9.0kg	
DOMESTIC WARRANTY	3 years	3 years	3 years	3 years	3 years	3 years	3 years	3 years	
PROFESSIONAL WARRANTY	2 years	2 years	2 years	2 years	2 years	2 years	2 years	3 years	



CHARGE 6 PORTABLE EGO BATTERIES AT THE SAME TIME

EGO's Professional Multi-Port Charging Case will charge any combination of up to six EGO portable batteries at the same time - ideal for professional users.

EGO's intelligent power management system charges batteries with the lowest level of charge first, then brings all the batteries up to full charge at the same rate. Charging 6x 10Ah batteries in as little as 3 hours in combination with the 1600W charger.

The Multi-Port Charging Case can be used directly with the EGO CHV1600E 1600W Charger or with the EGO 550W Rapid Charger (see page 113) when combined with the ACA1000 EGO Charging Adapter.

LED CHARGING INDICATOR



WALL MOUNTED

COOLING FAN

CHARGING CABLE HOOK



HINGED LID FOR WEATHER PROTECTION

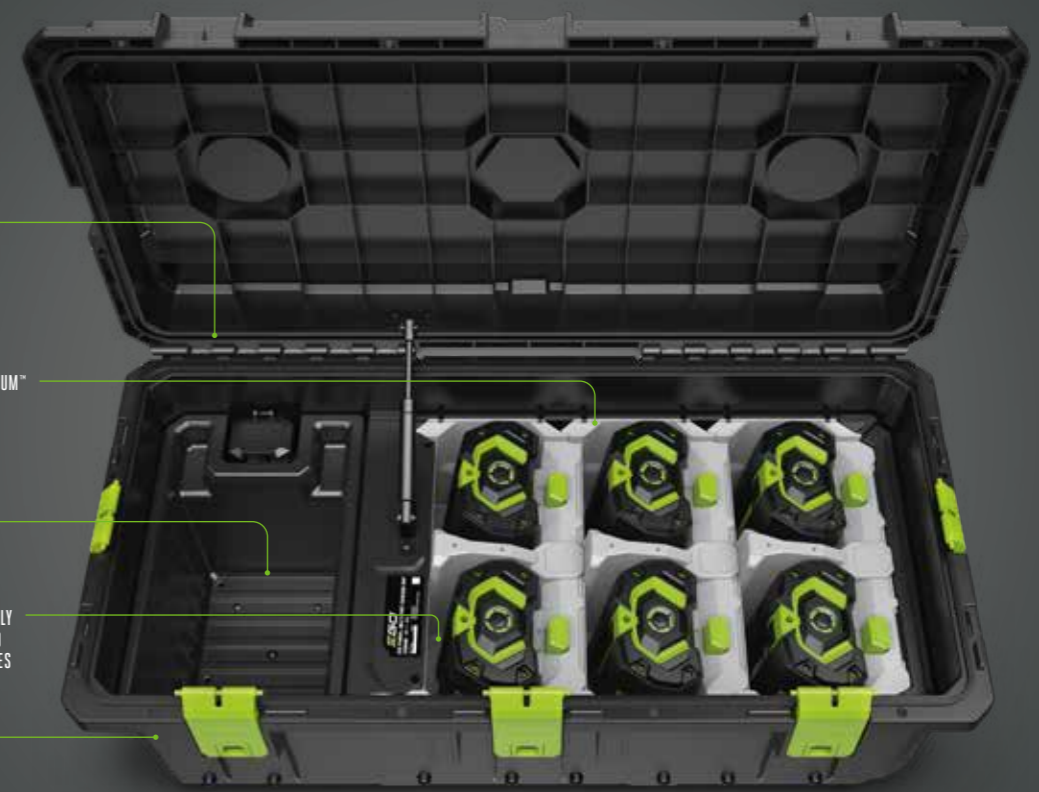

FITS ANY EGO ARC LITHIUM™ HAND-HELD BATTERY

STORAGE

SIMULTANEOUSLY CHARGES UP TO 6 EGO BATTERIES

WHEELED FOR EASY TRANSPORT TO JOB SITE

FOR USE WITH:



CHV1600E
1600W CHARGER



ACA1000
CHARGING ADAPTER
For use with the EGO 550W Rapid Charger

CHU6000
MULTI-PORT CHARGING CASE

includes CHV1600E 1600W charger



COMPARATIVE CHARGE TIMES

1600W CHARGER with case	6x 10Ah Portable Batteries	~ 3 Hours
550W RAPID CHARGER & CHARGING ADAPTER with case	6x 10Ah Portable Batteries	~ 8 Hours

A BATTERY FOR EVERY TOOL AND EVERY JOB

With a choice of 8 batteries and 1 battery backpack, choose the one that gives you the power and run time* you need.

KEY

- PROFESSIONAL
- PROFESSIONAL X
- RECOMMENDED / OPTIMAL
- COMPATIBLE / NOT OPTIMAL
- NOT RECOMMENDED



CODE	PRODUCT NAME	BATTERY																BACKPACK BATTERY					
		BA1400T 2.5Ah / 140Wh (Up to)	BA2240T/BA2242T 4.0Ah / 224Wh (Up to)	BA2800T 5.0Ah / 280Wh (Up to)	BA3360T 6.0Ah / 336Wh (Up to)	BA4200T 7.5Ah / 420Wh (Up to)	BA5600T 10.0Ah / 560Wh (Up to)	BA6720T 12.0Ah / 672Wh (Up to)	BAX1500 28Ah / 1568Wh (Up to)														
EGO Power+ Mowers		EGO Power+ Mowers																					
LM1700E	42cm Mower	Cuts up to 400sqm	Cuts up to 640sqm	Cuts up to 800sqm	Cuts up to 900sqm	Cuts up to 1200sqm	Cuts up to 1600sqm	Cuts up to 1900sqm									–						
LM1700E-SP	42cm Self-Propelled Mower	Cuts up to 300sqm	Cuts up to 480sqm	Cuts up to 600sqm	Cuts up to 800sqm	Cuts up to 900sqm	Cuts up to 1200sqm	Cuts up to 1400sqm									–						
LM1900E-SP	47cm Self-Propelled Mower	Cuts up to 400sqm	Cuts up to 640sqm	Cuts up to 800sqm	Cuts up to 900sqm	Cuts up to 1200sqm	Cuts up to 1600sqm	Cuts up to 1900sqm									–						
LM2020E-SP	50cm Self-Propelled Mower	Cuts up to 350sqm	Cuts up to 560sqm	Cuts up to 700sqm	Cuts up to 800sqm	Cuts up to 1050sqm	Cuts up to 1400sqm	Cuts up to 1700sqm									–						
LM2130E-SP	52cm Self-Propelled Mower with Select Cut Technology	Cuts up to 333sqm	Cuts up to 533sqm	Cuts up to 666sqm	Cuts up to 1000sqm	Cuts up to 1000sqm	Cuts up to 1333sqm	Cuts up to 1600sqm									–						
EGO Power+ Line Trimmers, Brush Cutter and Rotocut		EGO Power+ Line Trimmers, Brush Cutter and Rotocut																					
ST1300E-S	33cm Line Trimmer	70 mins	110 mins	140 mins	170 mins	210 mins	280 mins	340 mins									–						
ST1400E-ST	35cm Telescopic Line Trimmer with Powerload™ Technology	60 mins	90 mins	120 mins	135 mins	165 mins	240 mins	290 mins									660 mins						
ST1510E	38cm Line Trimmer with Powerload™ Technology	30 mins	50 mins	60 mins	70 mins	90 mins	120 mins	145 mins									–						
ST1530E	38cm Loop Handled Line Trimmer	18 mins	36 mins	45 mins	55 mins	72 mins	90 mins	110 mins									240 mins						
ST1610E-T	40cm Line Trimmer with Line IQ™ and Powerload™ Technology	40 mins	65 mins	85 mins	100 mins	125 mins	165 mins	200 mins									475 mins						
BCX3800E	38cm Bike Handled Brush Cutter	20 mins	32 mins	40 mins	50 mins	65 mins	80 mins	96 mins									280 mins						
BCX3800	Bike Handled Line Trimmer/Brush Cutter***	–	40 mins	50 mins	60 mins	75 mins	97 mins	120 mins									420 mins						
STX3800	Loop Handled Line Trimmer/Brush Cutter***	–	40 mins	50 mins	60 mins	72 mins	97 mins	116 mins									420 mins						
RTX2300	Rotocut (Assembled on BCX/STX3800)***	25 mins	40 mins	52 mins	65 mins	80 mins	105 mins	125 mins									325 mins						
EGO Power+ Hedge Trimmers		EGO Power+ Hedge Trimmers																					
HT2000E	51cm Hedge Trimmer	75 mins	120 mins	150 mins	210 mins	225 mins	300 mins	360 mins									–						
HT2410E	61cm Hedge Trimmer	75 mins	120 mins	150 mins	180 mins	225 mins	300 mins	360 mins									–						
HT2600E	66cm Hedge Trimmer	60 mins	90 mins	120 mins	145 mins	180 mins	240 mins	270 mins									–						
HT5100E	51cm Hedge Trimmer	40 mins	70 mins	82 mins	100 mins	125 mins	164 mins	195 mins									490 mins						
HT6500E	65cm Hedge Trimmer	33 mins	60 mins	72 mins	90 mins	110 mins	144 mins	170 mins									420 mins						
HTX6500	65cm Hedge Trimmer***	–	55 mins	70 mins	83 mins	105 mins	140 mins	170 mins									420 mins						
HTX7500	75cm Hedge Trimmer***	–	45 mins	60 mins	75 mins	90 mins	120 mins	145 mins									380 mins						
EGO Power+ Chainsaws		EGO Power+ Chainsaws																					
CS1400E	35cm Chainsaw	130 cuts	220 cuts	300 cuts	330 cuts	450 cuts	600 cuts	720 cuts									–						
CS1610E	40cm Chainsaw	130 cuts	220 cuts	300 cuts	330 cuts	450 cuts	600 cuts	720 cuts									–						
CS1800E	45cm Chainsaw with Auto Chain Tensioning	130 cuts	220 cuts	300 cuts	330 cuts	450 cuts	600 cuts	720 cuts									–						
CSX3000	30cm Top Handle Chainsaw	140 cuts	225 cuts	265 cuts	330 cuts	420 cuts	560 cuts	700 cuts									–						
PS1000E	Pole Saw System	70 cuts	110 cuts	140 cuts	170 cuts	210 cuts	285 cuts	340 cuts									780 cuts						
EGO Power+ Blowers		EGO Power+ Blowers																					
Run time in Mins		Low	High	Max	Low	High	Max	Low	High	Max	Low	High	Max	Low	High	Max	Low	High	Max	Low	High	Max	Max*
LB5300E	Blower 900m³/h	75	22	10	120	35	16	150	44	20	180	53	24	225	66	30	300	88	40	360	105	48	110 mins
LB5800E	Blower 986m³/h	100	15	9	160	24	14	200	30	18	240	36	22	300	45	27	400	60	36	480	72	36	110 mins
LB7650E	Blower 1300m³/h	30	13	–	120	20	14	150	25	17	180	30	18	225	37	26	300	50	34	360	60	40	–
LB6000E	Backpack Blower 1020m³/h	75	13	9	96	17	12	120	22	15	150	27	18	180	33	23	240	44	30	290	52	36	–
LBP8000E	Backpack Blower 1360m³/h	–	–	–	24	12	8	30	15	10	38	18	12	47	22	15	63	29	20	75	35	24	–
LBX6000	Blower 1014m³/h***	–	–	–	36 mins	–	–	60 mins	–	–	75 mins	–	–	90 mins	–	–	120 mins	–	–	145 mins	–	–	350 mins
EGO Power+ Multi-Tool		EGO Power+ Multi-Tool																					
STA1500	Multi-Tool Line Trimmer Attachment	18 mins	–	–	35 mins	–	–	45 mins	–	–	55 mins	–	–	72 mins	–	–	93 mins	–	–	110 mins	–	–	300 mins
STA1600	Multi-Tool Line Trimmer Attachment with Powerload™ Technology	18 mins	–	–	35 mins	–	–	45 mins	–	–	55 mins	–	–	70 mins	–	–	90 mins	–	–	110 mins	–	–	240 mins
BCA1200	Multi-Tool Brush Cutter Attachment	27 mins	–	–	50 mins	–	–	60 mins	–	–	75 mins	–	–	95 mins	–	–	125 mins	–	–	150 mins	–	–	375 mins
HTA2000	Multi-Tool Hedge Trimmer Attachment	37 mins	–	–	65 mins	–	–	82 mins	–	–	98 mins	–	–	122 mins	–	–	157 mins	–	–	188 mins	–	–	680 mins
HTA2000S	Multi-Tool Short Hedge Trimmer Attachment	37 mins	–	–	65 mins	–	–	82 mins	–	–	98 mins	–	–	122 mins	–	–	157 mins	–	–	188 mins	–	–	680 mins
PSA1000**	Multi-Tool Pole Saw Attachment	70 cuts	–	–	110 cuts	–	–	140 cuts	–	–	170 cuts	–	–	210 cuts	–	–	285 cuts	–	–	340 cuts	–	–	660 cuts
EA0800	Multi-Tool Edger Attachment	–	–	–	50 mins	–	–	60 mins	–	–	75 mins	–	–	100 mins	–	–	132 mins	–	–	158 mins	–	–	530 mins
CTA9500	Multi-Tool Cultivator Attachment	40 mins	–	–	60 mins	–	–	80 mins	–	–	100 mins	–	–	120 mins	–	–	160 mins	–	–	190 mins	–	–	480 mins
BBA2100	Multi-Tool Bristle Brush Attachment	50 mins	–	–	120 mins	–	–	120 mins	–	–	140 mins	–	–	150 mins	–	–	200 mins	–	–	280 mins	–	–	420 mins
OSA1000	Multi-Tool Olive Shaker Attachment	50 mins	–	–	80 mins	–	–	100 mins	–	–	120 mins	–	–	160 mins	–	–	210 mins	–	–	250 mins	–	–	660 mins
SSA1200	Multi-Tool Snow Shovel Attachment	45 mins	–	–	75 mins	–	–	90 mins	–	–	110 mins	–	–	135 mins	–	–	180 mins	–	–	216 mins	–	–	504 mins
RTA2300	Multi-Tool Rotocut Attachment	25 mins	–	–	40 mins	–	–	52 mins	–	–	60 mins	–	–	80 mins	–	–	105 mins	–	–	125 mins	–	–	325 mins
EGO Power+ Telescopic Pole System		EGO Power+ Telescopic Pole System																					
PSX2500	Pole Saw Attachment	110 cuts	–	–	182 cuts	–	–	231 cuts	–	–	280 cuts	–	–	379 cuts	–	–	455 cuts	–	–	545 cuts	–	–	1200 cuts
PTX5100	Hedge Trimmer Attachment	65 mins	–	–	95 mins	–	–	120 mins	–	–	140 mins	–	–	210 mins	–	–	260 mins	–	–	310 mins	–	–	720 mins
EGO Power+ Snow Throwers		EGO Power+ Snow Throwers																					
SNT2400E	2 Stage Snow Thrower	14 mins	–	–	22 mins	–	–	28 mins	–	–	30 mins	–	–	44 mins~	–	–	56 mins~	–	–	67 mins	–	–	–
SNT2120E-AP	Auger Propelled Snow Thrower	–	–	–	–	–	–	23 mins	–	–	28 mins	–	–	34 mins	–	–	45 mins	–	–	56 mins	–	–	–
EGO Power+ Lifestyle		EGO Power+ Lifestyle																					
Run time in Mins		Low	High	Max	Low	High	Max	Low	High	Max	Low	High	Max	Low	High	Max	Low	High	Max	Low	High	Max	Max*
FN1800E	45cm Misting Fan	1908	132	84	3048	210	132	3810	258	168	4572	312	198	5718	390	246	7620	522	330	9144	624	396	–
LT1000E	Portable Area Light	1080	150	****	1728	240	****	2160	300	****	2592	360	****	3240	450	****	4320	600	****	5184	720	****	–

* Run time may vary and depend on battery used, charge level of battery, condition of grass/hedge and user's operation technique
 ** Run time based on a 10cm x 10cm timber
 *** Portable batteries must be used with either BH1000 or BHX1000 harnesses
 **** The light will illuminate at 10,000lm in ambient temperature 25° C for 1 hour and will run for 2 more hours in brightness level 5. Please note that the 1 hour run time is dependent on ambient temperature. In a cooler environment the "Boost" mode will have a longer run time, but in a hot environment the "Boost" mode will have a shorter run time
 ~ Run times shown are for clearing up to 10cm of dry snow with 2x the battery listed. Run times vary based on snow depth, snow type and battery combinations

EGO[™]
POWER⁺ MOWER

WITH A RANGE OF CUTTING CAPACITIES,
SELF-PROPELLED MODELS, AND PUSH BUTTON
START, TACKLE ANY SIZE LAWN WITH EASE.





THE POWER OF PETROL WITHOUT THE EMISSIONS

With lower running costs, zero emissions and significantly quieter than a petrol mower, the EGO Power+ mower range offers a variety of key features and cutting capacities to suit any lawn.

The self-propelled motor keeps you in control and makes light work of slopes and undulations. On a single charge, our battery gives you up to 1,900 sqm cutting area*. Automatic Variable Speed on selected models, delivers optimal cutting speed to maximise battery run time whilst maintaining grass cutting performance for different conditions.

The 3-in-1 functionality lets you drop, bag or mulch clippings (mulching kits are sold separately), while the LED headlights let you work further into the day. The efficient grass collection system, uses all available space in the collection bag, meaning less-frequent emptying. And when you're done, the easy-fold design makes cleaning and storage simple.

*Based on a 12.0Ah battery using LM1900E-SP. Cutting area can vary depending on model and battery as well as condition of grass and user operation technique.



LED HEADLIGHTS
Work further into the day



SELF-PROPELLED MOTOR
Take the strain out of mowing sloping ground

PUSH BUTTON START
Power up in seconds

QUICK RELEASE TELESCOPIC HANDLE
For easy cleaning and compact storage



BAG FULL INDICATOR
Lets you know when the bag needs emptying

HIGH TORQUE, HIGH-EFFICIENCY MOTOR
For operation in all conditions

ADJUSTABLE HANDLE HEIGHT
Easily adjusts to suit you, and the job in hand

LARGE CAPACITY BAG
Collects more grass and requires emptying less frequently



LARGE DIAMETER WHEELS
For easy motion on different terrains

6-POSITION SPRING LOADED DECK HEIGHT ADJUSTMENT
Easily set different grass cutting heights from 20-95mm

AVAILABLE IN A RANGE OF CUTTING WIDTHS
42, 47, 50, and 52 cm cutting width options to suit any size of lawn

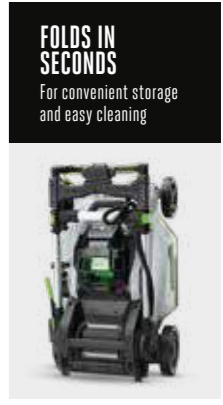

FOLDS IN SECONDS
For convenient storage and easy cleaning

Model shown: LM1900E-SP
Please note: some features are not available on all models.

A MOWER FOR EVERY LAWN THE RIGHT TOOL FOR THE JOB

The EGO Power+ mower range showcases a variety of specifications designed to make lawn care quicker, easier and more efficient. And with model sizes ranging from 42cm to 52cm cutting width, there's an option for every task and size of lawn.

Technologically advanced in every way, each mower packs incredible petrol-matching power as standard. Thanks to our revolutionary ARC Lithium™ 56V battery system, they make minimal noise, emit zero emissions, and start up at the touch of a button.

While these benefits apply to all EGO Power+ mowers, key differences make some models better suited to specific kinds of gardens.

Check out our handy diagram to the right to identify the size of lawn you can cut on a single charge, and therefore the mowers that are suitable for you.



Choosing the RIGHT mower:



Small, tight spaces, or close to trees.

For smaller spaces and improved precision around obstacles, mowers with a smaller cutting capacity are ideal.

Our compact 42cm models LM1700E or LM1700E-SP are perfect for smaller spaces.



Bigger, open spaces.

A mower with a wider cutting capacity will help you cover more ground in fewer passes. Opting for a bigger battery will increase run time, as will variable automatic cutting speed control. For a faster cut, a larger capacity bag can collect more grass and needs emptying less often.

Try our 52cm model LM2130E-SP which makes even the biggest jobs feel small.



Sloping ground.

Using a self-propelled mower takes the strain out of pushing the mower uphill.

Our self-propelled mowers, LM1700E-SP, LM1900E-SP, LM2020E-SP and LM2130E-SP are available in different cutting capacities to suit the size of your lawn, choose a wider cutting capacity for less passes.



Additional comfort.

If comfort is a priority, poly deck models are the lightest option. Self-propelled mowers require less effort, and with an adjustable handle, you can decide on the most suitable height.

Most of our mowers are available with a poly deck (Excluding LM2020E-SP) - just choose the cutting capacity to suit the size of your lawn.



Finishes.

The EGO Rear Roller Kit is a simple and effective way of enabling your EGO mower to stripe your lawn, giving you a manicured look whilst keeping the versatility of being able to mulch and rear discharge clippings.

REAR ROLLER KITS

Just add an EGO Rear Roller Kit to enable your EGO mower to stripe your lawn (please check that a Rear Roller Kit is available for your model - see below).



AR1700 available for LM1700E, LM1700E-SP
AR1900 available for LM1900E, LM1900E-SP
AR2100 available for LM2130E-SP

Grass cutting options.

There are 3 different ways that EGO Power+ mowers deal with cut grass. Great for lawns that aren't too thick, mulching redistributes grass particles and fertilising nutrients. Drop cuttings or rear discharge (side discharge for metal deck mower) allows for quicker mowing through thick and long grass. Bag collection keeps lawns clear of any cuttings.



MULCHING KITS

The EGO Power+ Mulching Kit will allow the mower to cut and distribute fine grass cuttings back into the lawn to help retain moisture and nutrients for a healthier lawn.

ABP1700 available for LM1700E, LM1700E-SP
ABP1900 available for LM1900E, LM1900E-SP

SELECT CUT X

Interchangeable multi-blade cutting system that allows you to choose between specialist mulching blade and bagging blade, to either distribute fine cuttings into your lawn or to collect cuttings into the large collection bag.

ABP2100D-E available for LM2130E-SP

LM1700E
42CM MOWER



Perfect for precision mowing in smaller spaces and medium sized gardens with level ground. Includes a 55L collection bag.



ACCESSORIES ALSO AVAILABLE



ONLY AVAILABLE AS KIT LM1701E

CUTS UP TO 400SQM ON A SINGLE CHARGE

LM1900E-SP
47CM SELF-PROPELLED MOWER



The wider cutting width is perfect for precision mowing of medium sized gardens. Self-propelled for tackling sloping lawns with ease. Includes a 55L collection bag.



ACCESSORIES ALSO AVAILABLE



ONLY AVAILABLE AS KIT LM1903E-SP

CUTS UP TO 800SQM ON A SINGLE CHARGE

LM1700E-SP
42CM SELF-PROPELLED MOWER



Perfect for mowing in smaller spaces and medium sized gardens. Self-propelled for tackling sloping and undulating lawns with ease. Includes a 55L collection bag.

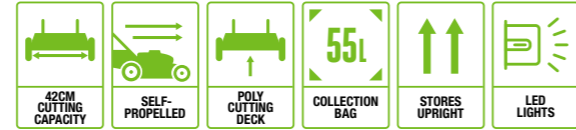

ACCESSORIES ALSO AVAILABLE



ONLY AVAILABLE AS KIT LM1702E-SP

CUTS UP TO 480SQM ON A SINGLE CHARGE

LM2020E-SP
50CM SELF-PROPELLED MOWER



The wide cutting width is perfect for precision mowing of medium and larger-sized gardens. Self-propelled with automatic variable cutting speed, ideal for large and sloping lawns. Includes a larger 60L collection bag.

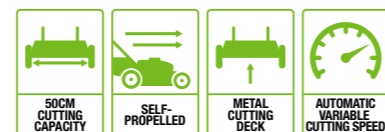

ACCESSORIES ALSO AVAILABLE



ONLY AVAILABLE AS KIT LM2021E-SP

CUTS UP TO 700SQM ON A SINGLE CHARGE

LM2130E-SP
52CM SELF-PROPELLED MOWER



The wide cutting width is perfect for precision mowing of larger gardens and wider spaces. Self-propelled with automatic variable cutting speed, ideal for large and sloping lawns. The Select Cut interchangeable multi-blade cutting system that allows you to choose between specialist mulching blade and bagging blade. Includes an extra-large 70L collection bag.

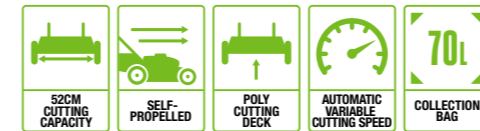

ACCESSORIES ALSO AVAILABLE



ONLY AVAILABLE AS KIT LM2135E-SP

CUTS UP TO 1000SQM ON A SINGLE CHARGE



Large capacity collection bag

	LM1700E	LM1700E-SP	LM1900E-SP	LM2020E-SP	LM2130E-SP
CUTTING CAPACITY	42cm	42cm	47cm	50cm	52cm
SELF-PROPELLED SPEED	No	0.5-1.4m/s (1.8-5.0km/h)	0.6-1.4m/s (2.2-5.0km/h)	0.6-1.4m/s (2.2-5.0km/h)	0.4-1.4 m/s (1.4-5km/h)
CUTTING DECK MATERIAL	Poly	Poly	Poly	Steel	Poly
CUTTING AREA*	2.5Ah	Cuts up to 400sqm	Cuts up to 300sqm	Cuts up to 350sqm	Cuts up to 333sqm
	4.0Ah	Cuts up to 640sqm	Cuts up to 480sqm	Cuts up to 560sqm	Cuts up to 533sqm
	5.0Ah	Cuts up to 800sqm	Cuts up to 600sqm	Cuts up to 640sqm	Cuts up to 666sqm
	6.0Ah	Cuts up to 900sqm	Cuts up to 800sqm	Cuts up to 800sqm	Cuts up to 1000sqm
	7.5Ah	Cuts up to 1200sqm	Cuts up to 900sqm	Cuts up to 900sqm	Cuts up to 1050sqm
	10.0Ah	Cuts up to 1600sqm	Cuts up to 1200sqm	Cuts up to 1600sqm	Cuts up to 1400sqm
	12.0Ah	Cuts up to 1900sqm	Cuts up to 1400sqm	Cuts up to 1900sqm	Cuts up to 1700sqm
CUTTING SPEED CONTROL	Constant speed	Constant speed	Constant speed	Automatic Variable Speed**	Automatic Variable Speed**
NO LOAD SPEED	3,000rpm	3,000rpm	2,850rpm	2,700 - 3,000rpm	2,700 - 3,000rpm
CUT HEIGHT SETTINGS	20/27/35/45/58/70/80mm	20/27/35/45/58/70/80mm	20/27/35/45/58/70/80mm	25/35/50/65/80/95mm	25/32/40/51/64/77/90mm
HANDLE HEIGHTS	Three - user adjustable	Three - user adjustable	Three - user adjustable	Three - user adjustable	Three - user adjustable
BAG CAPACITY	55L	55L	55L	60L	70L
FUNCTIONS	Mulch [†] , collect, rear discharge	Mulch [†] , collect, rear discharge	Mulch [†] , collect, rear discharge	Mulch, collect, side discharge	Mulching and collect
NOISE RATING LpA/LwA	78dB(A) 95dB(A)	78dB(A) 95dB(A)	80dB(A) 95dB(A)	80dB(A) 93dB(A)	80dB(A) 90dB(A)
VIBRATION (M/S ²)	2.4	1.5	1.4	1	0.6
VERTICAL STORAGE	Yes	Yes	Yes	Yes	Yes
WEIGHT WITHOUT BATTERY	22kg	25kg	25kg	27kg	26kg
MOTOR TYPE	Brushless	Brushless	Brushless	Brushless	Brushless
DOMESTIC WARRANTY	5 years	5 years	5 years	5 years	5 years
PROFESSIONAL WARRANTY	1 year	1 year	1 year	2 years	2 years
AVAILABLE AS A KIT	LM1701E: Includes mower, 2.5Ah battery and standard charger	LM1702E-SP: Includes self-propelled mower, 4Ah battery and standard charger	LM1903E-SP: Includes self-propelled mower, 5Ah battery and rapid charger	LM2021E-SP: Includes self-propelled mower, 5Ah battery and rapid charger	LM2135-SP: Includes self-propelled mower, 7.5Ah battery and rapid charger

*Cutting area may vary and depend on the battery used, charge level of battery, condition of grass, and user's operation technique.

**Automatic Variable Speed delivers optimal cutting speed to maximise battery run time whilst maintaining grass cutting performance.

†Please note, mulching kits for models LM1700E, LM1700E-SP, LM1900E-SP and LM2130E-SP are available separately to purchase (ABP1700, ABP1900 and ABP2100D-E).

• - highlighted cutting area is optimal for battery.

EGO

POWER+ Z6 ZERO-TURN
RIDE-ON MOWER



EGO'S Z6 RANGE DELIVERS POWER THAT GOES BEYOND THE COMPETITION. PEAK POWER™ TECHNOLOGY COMBINES THE OPTIMAL POWER OF UP TO 6X 56V EGO ARC LITHIUM™ BATTERIES FOR TRULY EXCEPTIONAL PERFORMANCE.



Z6

TRULY GROUND-BREAKING TECHNOLOGY

EGO's ride-on mower range has returned with another industry-first for 2023, introducing its first ever Z6 steering wheel model featuring new e-Steer™ Technology for advanced steering control and confidence.

Our newest Z6 model drives like a car and turns like a zero-turn simultaneously, with a precision steering wheel and the latest in digital steering technology – as well as offering the same world-first battery platform-compatibility as all EGO ride-on models.

Delivering the equivalent power of a 22-horsepower petrol engine, with none of the emissions, EGO ZTRs cover up to 2.5 acres on a single charge with six 12Ah batteries. You can tailor the combination of batteries to suit the size of your lawn and grass-cutting preferences. The fast charger fully charges 6x 10Ah batteries in as little as just 3 hours.



EGO's revolutionary e-Steer™ Technology provides the ultimate in control and precision meaning the latest Z6 model drives like a car and steers like a zero-turn ride-on mower.



DRIVE LIKE A CAR. STEER WITH CONFIDENCE – THE BRAND-NEW PRECISION STEERING WHEEL OFFERS ULTIMATE CONTROL

COMFORTABLE SEAT WITH AIR-RIDE SUSPENSION

NEW FOR 2023

USEFUL STORAGE
For phones, keys, and drinks

4 BLADE SPEEDS
For cutting efficiency



INDIVIDUAL MOTORS
For each blade

PRESSED STEEL DECK

LED LIGHTS



NEW FOR 2023

ZT4200E-S 107CM Z6 ZERO TURN MOWER WITH E-STEER™ TECHNOLOGY

The new Z6 ZT4200E-S drives like a car and turns like a zero-turn ride-on mower. The innovative precision steering wheel ensures you have all controls at your fingertips for optimum ease and accuracy. Equipped with the latest in digital technology and cruise control, the Z6 takes manoeuvrability to the next level with 3 customisable driving modes: Control, Standard and Sport.

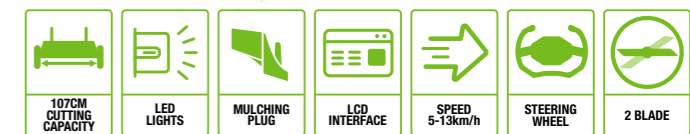

ACCESSORIES ALSO AVAILABLE



3 CUTTING MODES

Side discharge, mulching, and collection

CRUISE CONTROL
For mowing comfort





Cuts up to 2.5 acres on a single charge with six 12Ah batteries

Fully customisable to suit your ride

22 horsepower equivalent

3-in-1 Functionality - Side Discharge, Mulch or Collect (bag available to purchase separately)

EGO POWER+ **NEW FOR 2023**

ZT5200E-L
132CM Z6 ZERO TURN RIDING MOWER

The new, larger ZT5200E-L 3-bladed mower has a fabricated deck and larger wheels to support any additional weight, as well as a range of comfort features. The lap bars make for an intuitive operation while the 3 driving modes and 4 blade speeds allow you to fully customise your ride.

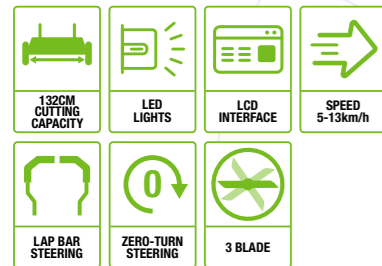

ACCESSORIES ALSO AVAILABLE



LARGER WHEELS
To support any additional weight



FABRICATED DECK

3 BLADES



ZT4200E-L
107CM Z6 ZERO TURN RIDING MOWER

Ideal for larger gardens, the Z6 handles corners with ease. Customise the ride with an LCD interface featuring 3 driving modes: Control, Standard and Sport, which can be accessed with the simple touch of a finger. Includes a hydraulic seat for added comfort.

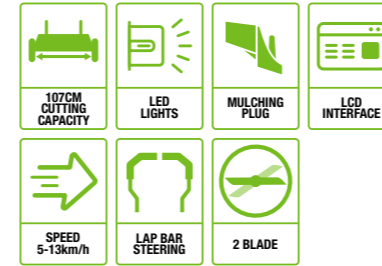

ACCESSORIES ALSO AVAILABLE



Scan here to explore our battery combinations for your Z6.

	ZT4200E-S	ZT4200E-L	ZT5200E-L
NUMBER OF BLADES	2	2	3
CUTTING WIDTH	107cm	107cm	132cm
STEERING	Steering wheel	Lap Bar	Lap Bar
SPEED	5-13 km/h	5-13 km/h	8-13km/h
DECK LIFTING	Manual	Manual	Manual
CUTTING HEIGHT	25mm-100mm, 10 settings	25mm-100mm, 10 settings	25mm-100mm, 10 settings
FUNCTIONS	Mulch, collect, side discharge	Mulch, collect, side discharge	Mulch, collect, side discharge
REAR COLLECTION	230L	230L	230L
SEAT SUSPENSION	Hydraulic	Hydraulic	Hydraulic
NOISE RATING LpA/LwA	84dB(A) 96dB(A)	84dB(A) 96dB(A)	84dB(A) 96dB(A)
WEIGHT	195kg	195kg	217kg
DOMESTIC WARRANTY	5 years	5 years	5 years
PROFESSIONAL WARRANTY	1 year	1 year	1 year
SUPPLIED COMPLETE AS:	ZT4201E-S: Includes ride-on mower, 2x blades, mulching plug and 1600W charger	ZT4201E-L: Includes ride-on mower, mulching plug and 1600W charger	ZT5201E-L: Includes ride-on mower, 3x blades and 1600W charger

*Run time may vary based on the batteries used, charge level of batteries, condition of grass and user's operation technique. The Z6 needs a minimum of 15Ah to function.



PEAK POWER+TM
TECHNOLOGY

Dialling up the power for those tough tasks has never been easier.

Peak Power™ Technology combines the power from your choice of two to six EGO 56V ARC Lithium™ batteries to deliver the performance of a petrol mower. The convenience of universal battery compatibility means the battery can be used in any other EGO Power+ tool, so you can switch between tools in a matter of clicks.

EGO[™]
POWER⁺ CHAINSAW

BUILT FOR THE TOUGHEST JOBS, POWERED
BY OUR 56V ARC LITHIUM[™] BATTERY
TECHNOLOGY, NOTHING GETS IN THEIR WAY.



BUILT FOR THE TOUGHEST TASKS

The EGO Power+ chainsaws are built to tackle even the hardest jobs. Trunks, logs, branches, nothing gets in their way.

Choose simple, safe Auto Chain Tensioning to maintain proper tension during use or opt for tool-free chain tensioning for easy set-up and adjustment. Check the lubrication level through the oil inspection window and you're ready to go.

The electronic chain brake protects against kickback while you work. And, the auto-lubrication system keeps the chain moving freely at all times.

Plus with EGO's 56V ARC Lithium™ battery delivering such an impressive run time and incredible power on a single charge, it'll keep you working cut after cut after cut.



EFFICIENT AND POWERFUL BRUSHLESS MOTOR

CHAIN BRAKE
For safe operation

LED LIGHT
For use in low light conditions

AUTOMATIC CHAIN OILING
For better cutting performance

OPAQUE OIL LEVEL INSPECTION WINDOW

BUMPER SPIKES
For control when cutting logs

DURABLE 45CM, 18" GUIDE BAR



AUTO CHAIN TENSIONING

For simple chain tensioning*



FAST CHAIN SPEED - 20.0M/S
For smooth, easy cut through large trunks and logs

AUTO CHAIN TENSIONING

SIMPLE, SAFE CHAIN TENSIONING

The EGO Power+ 18 inch chainsaw with Auto Chain Tensioning is built to tackle tough jobs. With a high speed 20m/s chain speed and a powerful motor, nothing will get in its way.

All guesswork is removed when it comes to the correct chain tension thanks to an auto tensioning feature. When replacing or tensioning the chain, simply loosen the sprocket cover on the saw, re-tighten and you're ready to go.



SIMPLE ADJUSTMENT

For safe and effective chain tensioning.

Please note: some features are not available on all models.

Model shown: CS1800E

*Available on selected models.



Durable bar and chain



**CS1800E
45CM CHAINSAW**

A chain speed of 20m/s, provides all the power and torque needed to quickly cut through thick branches and larger logs up to 45cm (17.5ins) in width.

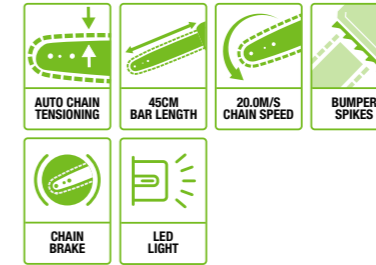
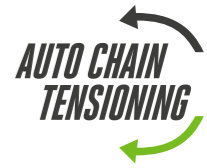

**CS1400E
35CM CHAINSAW**

Perfect for easily cutting through branches and medium-sized logs up to 35cm (approx. 14ins) in width.

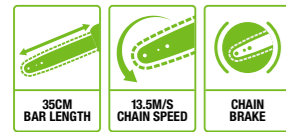

AVAILABLE AS A KIT



**CS1610E
40CM CHAINSAW**

An outstanding combination of high torque and chain speed – perfect for easily cutting through branches and medium-sized logs up to 40cm (approx. 16ins) in width.

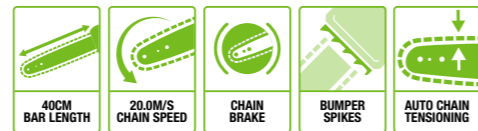

AVAILABLE AS A KIT



**BCS1000
CHAINSAW BAG**

Durable bag with oil tray and folding scabbard cover for safely transporting chainsaws. Separate pockets for storing accessories.



Available separately, see page 114.

	CS1400E	CS1610E	CS1800E
BLADE LENGTH	35cm	40cm	45cm
CHAIN SPEED	13.5m/s	20m/s	20m/s
CUTS UP TO*	2.5Ah Up to 130 cuts 4.0Ah Up to 220 cuts 5.0Ah Up to 300 cuts 6.0Ah Up to 330 cuts 7.5Ah Up to 450 cuts 10.0Ah Up to 600 cuts 12.0Ah Up to 720 cuts	2.5Ah Up to 130 cuts 4.0Ah Up to 220 cuts 5.0Ah Up to 300 cuts 6.0Ah Up to 330 cuts 7.5Ah Up to 450 cuts 10.0Ah Up to 600 cuts 12.0Ah Up to 720 cuts	2.5Ah Up to 130 cuts 4.0Ah Up to 220 cuts 5.0Ah Up to 300 cuts 6.0Ah Up to 330 cuts 7.5Ah Up to 450 cuts 10.0Ah Up to 600 cuts 12.0Ah Up to 720 cuts
CHAIN BAR	AG1400	AG1600	AG1800
CHAIN TYPE	AC1400 (90PX – 3/8" x 1.1mm)	AC1600 (90PX – 3/8" x 1.1mm)	AC1800 (91PX – 3/8" x 1.3mm)
OIL RESERVOIR	150ml	150ml	200ml
CHAIN OIL	Automatic	Automatic	Automatic
CHAIN BRAKE	Yes	Yes	Yes
NOISE RATING LpA/LwA	86dB(A) 100dB(A)	91dB(A) 102dB(A)	93dB(A) 104dB(A)
VIBRATION (M/S²)	5.4/4.1	3.4/2.8	5.1/3.5
CHAIN TENSIONING	Tool free	Semi automatic	Automatic
WEIGHT WITHOUT BATTERY	3.8kg	4.1kg	4.5kg
MOTOR TYPE	Brushless	Brushless	Brushless
DOMESTIC WARRANTY	5 years	5 years	5 years
PROFESSIONAL WARRANTY	1 year	1 year	2 years
AVAILABLE AS A KIT	CS1401E: Includes chainsaw, 2.5Ah battery and standard charger	CS1614E: Includes chainsaw, 5Ah battery and fast charger	-

*Number of cuts may vary and depend on the battery used, charge level of battery and user's operation technique. Based on 100mm x 100mm cuts.
● - highlighted cutting area is optimal for battery.

EASIER, SAFER, TREE SURGERY

Created with arborist specialists in mind, EGO's Professional-X CSX3000 Top Handle Chainsaw is an exceptional combination of torque and power.

With industry-leading ARC Lithium™ battery technology at its core, the Top Handle Chainsaw provides the optimum combination of power, torque, and chain speed.

Benefiting from long run-times and fast recharge, it's built to tackle tough, all-day use. The Chainsaw's unique Chain Brake Safety System stops the tool's motor if kickback occurs, reducing the risk of injury.

Additional features of Battery-Level and Oil Indicator lights alert you when you're running low, making the tool suitable for every tree-top task. With a range of chain bars from 12" to 16" available, the EGO Top Handle Chainsaw makes jobs easier, cleaner, quieter and safer.

BATTERY-LEVEL AND OIL INDICATOR LIGHT ALERTS
Provides warning when power and oil levels are running low

IMPRESSIVE USER COMFORT AND SAFETY
Low vibration and noise levels and zero emissions

CHAIN-BRAKE SAFETY SYSTEM
Stops the motor in its tracks if kickback occurs

METAL BUMPER SPIKES
For better grip during cuts

SIGHTLINES
Helping operators make accurate cuts

TOP HANDLE TRIGGER
Provides power when you need it, no need for a pull cord

COMPATIBLE WITH A RANGE OF CHAIN BARS
From 12" - 16"



CSX3000 PROFESSIONAL-X TOP HANDLE CHAINSAW

Designed to deliver a best-in-class combination of power, torque and chain speed for the professional arborist.

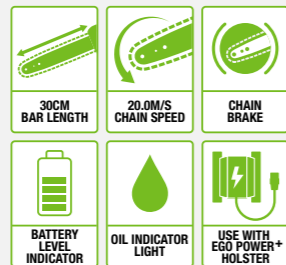

	CSX3000
BLADE LENGTH	30cm
CHAIN SPEED	20m/s
CUTS UP TO*	2.5Ah Up to 140 cuts 4.0Ah Up to 225 cuts 5.0Ah Up to 265 cuts 6.0Ah Up to 330 cuts 7.5Ah Up to 420 cuts 10.0Ah Up to 560 cuts 12.0Ah Up to 700 cuts
CHAIN BAR	AG1200
CHAIN TYPE	AC1200 (90PX - 3/8" x 1.1mm)
OIL RESERVOIR	200ml
CHAIN OIL	Automatic - Worm drive adjustable
CHAIN BRAKE	Yes - Mechanical and Electronic
NOISE RATING LpA/LwA	88dB(A) 98dB(A)
VIBRATION (M/S²)	1.7/2.2
CHAIN TENSIONING	Side
WEIGHT WITHOUT BATTERY	3.5kg
MOTOR TYPE	Brushless
DOMESTIC WARRANTY	Not suitable
PROFESSIONAL WARRANTY	3 years
AVAILABLE AS A KIT	CSX3002: Includes top handle chainsaw, 4Ah battery and rapid charger

*Number of cuts may vary and depend on the battery used, charge level of battery and user's operation technique. Based on 100mm x 100mm cuts. - highlighted cutting area is optimal for battery.

ABH3000 BATTERY HOLSTER

BA2240T 4AH BATTERY

Battery holster cable integrates with the safety strap to securely attach to the belt and harness. The 4Ah battery has been designed with the optimal power-to-weight ratio for use by professional arborists.

Available separately, see pages 23 and 24.

REACH NEW HEIGHTS

The EGO Pole Saw makes ladders and tricky tree maintenance a thing of the past.

With a 25cm bar and chain speeds of up to 20m/s, the EGO Pole Saw cuts through high branches with ease. The cutting head and shaft attach to the tool via a connector, allowing the Pole Saw to be stored compactly. Switch up the length of the tool up to 4m to reach any branch, however near or far, with the telescopic feature. The lightweight, sturdy, carbon fibre shaft and LED cutting guides aid manoeuvrability and keep cuts accurate.



PS1000E TELESCOPIC POLE SAW

Work on those hard-to-reach areas with ease. Our lightweight EGO Telescopic Pole Saw reaches lengths of 4m when fully extended and, thanks to its motor located at the head of the tool, maintains great balance and ergonomics.

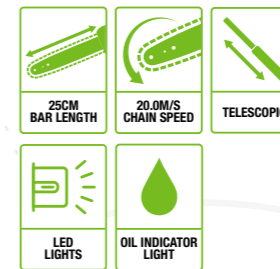

NEW FOR 2023

FELLING LINE FOR ACCURATE CUTS WITH LED LIGHT

FRONT-MOUNTED MOTOR AND OIL SYSTEM

TELESCOPIC FEATURE

TOOL FREE FILLER

TOOL FREE CHAIN TENSIONING

HIGH CHAIN SPEED FOR CLEAN CUTS

BRANCH-GRABBING HOOK

TOOL FREE HANDLE ADJUSTER

	PS1000E
BAR LENGTH	25cm
CHAIN TYPE	Gauge 0.043", pitch 1/4"
CUTS UP TO*	2.5Ah Up to 70 cuts 4.0Ah Up to 110 cuts 5.0Ah Up to 140 cuts 6.0Ah Up to 170 cuts 7.5Ah Up to 210 cuts 10.0Ah Up to 285 cuts 12.0Ah Up to 340 cuts
CHAIN SPEED	20m/s
TOTAL EXTENDED LENGTH	296cm (tool) 396cm (with one extension pole) 496cm (with two extension poles)
OIL RESERVOIR	80ml
CHAIN OIL	Automatic
NOISE RATING LpA/LwA	82dB(A) 100dB(A)
VIBRATION (M/S²)	1.01/1.51
CHAIN TENSIONING	Automatic
WEIGHT WITHOUT BATTERY	4.25kg
MOTOR TYPE	Brushless
DOMESTIC WARRANTY	5 years
PROFESSIONAL WARRANTY	2 years
AVAILABLE AS A KIT	PS1003E: Includes telescopic pole saw, extension pole, 4Ah battery and standard charger

*Number of cuts may vary and depend on the battery used, charge level of battery and user's operation technique. Based on 100mm x 100mm cuts. - highlighted cutting area is optimal for battery.



EP1000 EXTENSION POLE

Nothing is out of reach with this strong yet lightweight extension pole.

EGO

POWER⁺ PROFESSIONAL X
TELESCOPIC POLE SYSTEM

MAXIMUM REACH, MANOEUVRABILITY AND CUTTING
POWER FOR HIGH BRANCHES AND HEDGES.



REACH HIGH BRANCHES WITHOUT ADDITIONAL EQUIPMENT

EGO's Telescopic Pole system enables you to work on those harder-to-reach jobs with ease.

Switch between a Pruning Saw or Hedge Trimmer attachment in a matter of seconds.

The Telescopic Pole houses the battery and dual-trigger controls and has an extendable reach of up to 4 metres.

When fully extended, the tool maintains great balance, articulation, and ergonomics.



DOUBLE TRIGGER CONTROLS
Comfortable, safe and reliable

DUAL LOCKING SYSTEM
Easy to change attachment with thumb screw locking

IN-LINE BATTERY POSITION
For optimum balance during use

ALUMINIUM OVAL SHAFT
Robust design for comfort, grip and reach

PROFESSIONAL-X TELESCOPIC HEDGE TRIMMER ATTACHMENT
Cut branches up to 26mm in diameter. 6-position articulation and additional twist rotation

PROFESSIONAL-X TELESCOPIC PRUNING SAW ATTACHMENT
The power, torque and chain-speed to cut branches up to 200mm in diameter



REAR FOOT
Replaceable carrying handle, protection against bumping and dropping

PPX1000 PROFESSIONAL-X TELESCOPIC POLE

Use with the EGO Power+ Professional-X Pruning Saw and Hedge Trimmer attachments*, and with any of EGO's 56V ARC Lithium™ batteries. Extends up to 4m** in length to easily reach high branches and hedges, and ideal for low hedges when set to a shorter extension.



	PPX1000
LENGTH	172 - 265cm
IP CLASS	IPX4
SPEED CONTROL	Variable speed 2 triggers
SHAFT MATERIAL	Oval, rubber sleeve
WEIGHT WITHOUT BATTERY	3.5kg
DOMESTIC WARRANTY	5 years
PROFESSIONAL WARRANTY	3 years
AVAILABLE AS A KIT*	PPCX1000: Includes telescopic pole, pruning saw attachment and hedge trimmer attachment

*Without battery and charger.

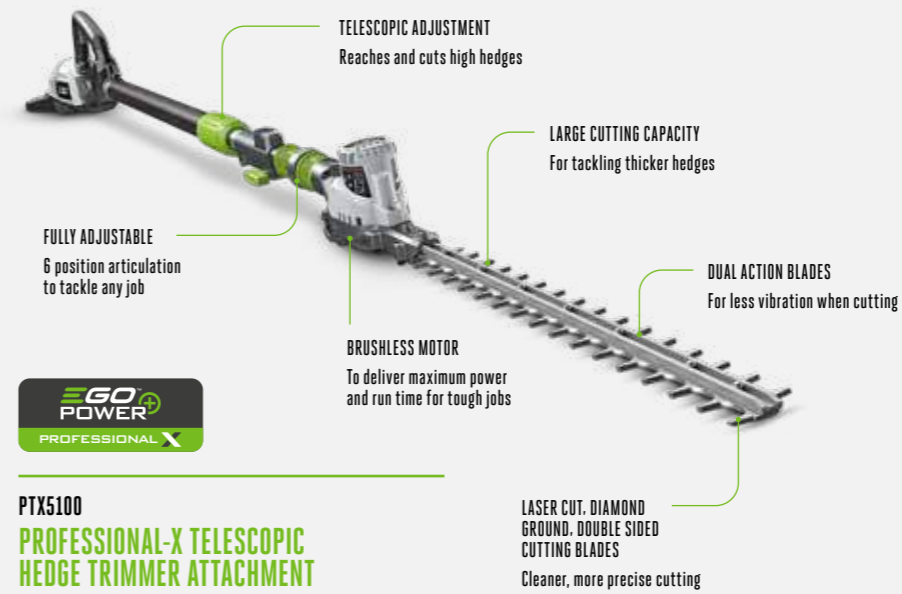

PTX5100 PROFESSIONAL-X TELESCOPIC HEDGE TRIMMER ATTACHMENT

For use with the EGO Power+ Professional-X Telescopic Pole (sold separately). Cut branches up to 26mm with ease. Tackle hard-to-reach areas with 6-position articulation and twist rotation.

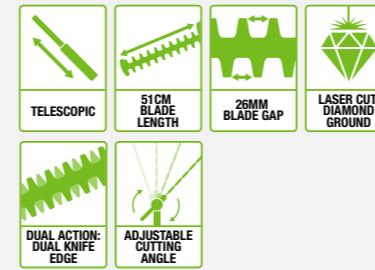

PSX2500 PROFESSIONAL-X TELESCOPIC PRUNING SAW ATTACHMENT

For use with the EGO Power+ Professional-X Telescopic Pole (sold separately). Cut through branches up to 200mm in diameter with ease.



	PTX5100
BLADE LENGTH	51cm
BLADE GAP	26mm
BLADE TOOTH DEPTH	1.8mm
RUN TIME*	2.5Ah Up to 65 mins 4.0Ah Up to 95 mins 5.0Ah Up to 120 mins 6.0Ah Up to 140 mins 7.5Ah Up to 210 mins 10.0Ah Up to 260 mins 12.0Ah Up to 310 mins
SPEED CONTROL	Variable Speed
NO LOAD SPEEDS	3,000spm
BLADE TYPE	Laser cut, diamond ground
CUTTING ACTION	Dual action double sided
BLADE TIP PROTECTOR	No
NOISE RATING LpA/LwA	83 dB(A) 94 dB(A)
ROTATING GEARHEAD	Up 45° to down 70° Left and right +90° to -90°
WEIGHT WITHOUT BATTERY	2.3kg
MOTOR TYPE	Brushless
VIBRATION (M/S²)	1.3m/s² - 1.5m/s²
DOMESTIC WARRANTY	5 years
PROFESSIONAL WARRANTY	3 years
AVAILABLE AS A KIT**	PPCX1000: Includes telescopic pole, pruning saw attachment and hedge trimmer attachment

*Run time may vary and depend on the battery used, charge level of battery, condition of hedge and user's operation technique.
**Without battery and charger.

	PSX2500
BAR LENGTH	25cm
CHAIN TYPE	90PX040X (Pitch 3/8", Gauge 1.1mm)
CHAIN SPEED	22m/s
RUN TIME*	2.5Ah Up to 110 cuts 4.0Ah Up to 182 cuts 5.0Ah Up to 231 cuts 6.0Ah Up to 280 cuts 7.5Ah Up to 379 cuts 10.0Ah Up to 455 cuts 12.0Ah Up to 545 cuts
SPEED CONTROL	Variable Speed
TOTAL LENGTH	140cm
TOTAL EXTENDED LENGTH	400cm
OIL TANK CAPACITY	180ml with worm gear
NOISE RATING LpA/LwA	85 dB(A) / 99 dB(A)
WEIGHT WITHOUT BATTERY	2.2kg
MOTOR TYPE	Brushless
VIBRATION (M/S²)	1.2m/s²
DOMESTIC WARRANTY	5 years
PROFESSIONAL WARRANTY	3 years
AVAILABLE AS A KIT**	PPCX1000: Includes telescopic pole, pruning saw attachment and hedge trimmer attachment

*Number of cuts may vary and depend on the battery used, charge level of battery and user's operation technique. Based on 100mm x 100mm cuts. **Without battery and charger.

EGO[™]

POWER⁺ LINE TRIMMER
& BRUSH CUTTER

THE PERFECT COMBINATION OF POWER, BALANCE
AND COMFORT. OUR LINE TRIMMERS AND
BRUSH CUTTERS CUT EVERY JOB DOWN TO SIZE.





NEW FOR 2023

ULTIMATE TRIMMING CONTROL

EGO has revolutionised its range of Power+ Line Trimmers once more, with the introduction of world-first Line IQ™ Technology to its newest model for non-stop performance.

EGO's latest innovation features auto-sensors which monitor and automatically feed the length of line so there's no bump needed. Coupled with EGO's patented Powerload™ Technology, it's designed to eliminate the usual hassle so you can focus on the job at hand.

With a range of cutting swathes and speeds, there's an EGO Line Trimmer suitable for every use, from smaller gardens to more demanding, professional jobs. Backed by powerful brushless motors and created with ease-of-use in mind, EGO Power+ Line Trimmers deliver optimum efficiency and runtime, as well as low vibration levels and adjustable shaft length for comfortable working conditions.



LINE-IQ™ TECHNOLOGY

Forget frustrating line feeding issues with EGO's automatic Line IQ™ Technology. With intelligent automatic sensors, there's no need to bump the head, so you can keep trimming for non-stop performance.





**ST1300E-S
33CM LINE TRIMMER**

Two-speed, 33cm cutting swathe with bump head line feed and easy line replacement. Ideal for the smaller garden.



AVAILABLE AS A KIT ST1301E-S
Includes AP1500 Single Shoulder Harness

- 33CM CUTTING WIDTH
- TWO SPEED
- 2.0MM LINE DIAMETER
- BUMP LINE FEED
- QUICK-ADJUST HANDLE



POWERLOAD™ TECHNOLOGY

**ST1400E-ST
35CM LINE TRIMMER**

35cm cutting swathe with Powerload™ Technology for automatic line replacement. Features a telescopic shaft for adjustment to fit any user and adjustable handle for edge-trimming of lawns.



AVAILABLE AS A KIT ST1401E-ST
Includes AP1500 Single Shoulder Harness

- 35CM CUTTING WIDTH
- 2.4MM LINE DIAMETER
- QUICK-ADJUST HANDLE
- BUMP LINE FEED
- VARIABLE SPEED
- TELESCOPIC
- POWERLOAD™ HEAD



POWERLOAD™ TECHNOLOGY

**ST1510E
38CM LINE TRIMMER**

Featuring Powerload™ Technology for automatic line replacement, variable speed and large 38cm cutting swathe.



AVAILABLE AS A KIT ST1511E
Includes AP1500 Single Shoulder Harness

- 38CM CUTTING WIDTH
- VARIABLE SPEED
- 2.4MM LINE DIAMETER
- QUICK-ADJUST HANDLE
- BUMP LINE FEED
- POWERLOAD™ HEAD



**ST1530E
38CM LINE TRIMMER**

Variable speed, large 38cm cutting swathe with bump head line feed and rapid reload line replacement.



Includes AP1500 Single Shoulder Harness

- 38CM CUTTING WIDTH
- VARIABLE SPEED
- 2.4MM LINE DIAMETER
- BUMP LINE FEED
- ANY INSERT HEAD
- QUICK-ADJUST HANDLE
- CAN BE USED WITH ROTOCUT



POWERLOAD™ TECHNOLOGY **LINE-IQ™ TECHNOLOGY**

NEW FOR 2023

**ST1610E-T
40CM LINE TRIMMER**

Overcome the tricky, time-consuming challenges of loading and feeding line with the industry's most innovative Line Trimmer. EGO Powerload™ and Line IQ™ Technologies make tackling trimming tasks the easiest they've ever been, combined with a 40cm cutting swathe and 2 pre-set speeds. The new ST1610E-T's ergonomic design and industry-first technology features make it a truly remarkable trimming tool.



AVAILABLE AS A KIT ST1613E-T

- 40CM CUTTING WIDTH
- 2.4MM LINE DIAMETER
- QUICK-ADJUST HANDLE
- VARIABLE SPEED
- TELESCOPIC
- POWERLOAD™ HEAD
- LINE IQ™ TECHNOLOGY

POWERLOAD™ TECHNOLOGY

Solving one of the biggest frustrations of line replacement, EGO's groundbreaking Powerload™ Technology automatically loads the line into the trimmer head. Just thread the line, press the Powerload™ button and let the tool do the rest. Available on ST1510E, ST1400E-ST and ST1610E-T.



STEP 1
Thread the line.



STEP 2
Press the Powerload™ button to load new line.

	ST1300E-S	ST1400E-ST	ST1510E	ST1530E	ST1610E-T
CUTTING WIDTH – Line trimmer head	33cm	35cm	38cm	38cm	40cm
TOTAL LENGTH	173cm	165-183cm	173cm	167cm	184cm
RUN TIME*	2.5Ah Up to 70 mins 4.0Ah Up to 110 mins 5.0Ah Up to 140 mins 6.0Ah Up to 170 mins 7.5Ah Up to 210 mins 10.0Ah Up to 280 mins 12.0Ah Up to 340 mins	2.5Ah Up to 60 mins 4.0Ah Up to 90 mins 5.0Ah Up to 120 mins 6.0Ah Up to 135 mins 7.5Ah Up to 165 mins 10.0Ah Up to 240 mins 12.0Ah Up to 290 mins	2.5Ah Up to 30 mins 4.0Ah Up to 50 mins 5.0Ah Up to 60 mins 6.0Ah Up to 70 mins 7.5Ah Up to 90 mins 10.0Ah Up to 120 mins 12.0Ah Up to 145 mins	2.5Ah Up to 18 mins 4.0Ah Up to 36 mins 5.0Ah Up to 45 mins 6.0Ah Up to 55 mins 7.5Ah Up to 72 mins 10.0Ah Up to 90 mins 12.0Ah Up to 110 mins	2.5Ah Up to 40 mins 4.0Ah Up to 65 mins 5.0Ah Up to 85 mins 6.0Ah Up to 100 mins 7.5Ah Up to 125 mins 10.0Ah Up to 165 mins 12.0Ah Up to 200 mins
SPEED CONTROL	Constant speed Two-speed	Variable speed Two-speed	Constant speed Two-speed	Constant speed Two-speed	Digital 2 speed Variable speed
NO LOAD SPEEDS	5,200-6,500rpm	3,500-5,800rpm	4,000-5,800rpm	6,000-7,000rpm	3,500-5,500rpm
LINE DIAMETER SUPPLIED**	2.0mm	2.4mm	2.4mm	2.4mm	2.4mm
LINE FEED	Bump feed head	Powerload™ head	Powerload™ head	Rapid reload bump feed head	Line-IQ feed
DUAL LINE	Yes	Yes	Yes	Yes	Yes
ROTATING DIRECTION	Clockwise	Clockwise	Clockwise	Anti clockwise	Clockwise
AUXILIARY HANDLE	Loop and quick-adjust	Loop and quick-adjust	Loop and quick-adjust	Loop and quick-adjust	Quick adjust
HARNESS	N/A	N/A	Single shoulder	Single shoulder	Single shoulder
WEIGHT WITHOUT BATTERY	2.7kg	3.4kg	3.2kg	4.2kg	3.4kg
VIBRATION (M/S²)	2.1/1.2	3.2/2.3	1.1/1.5	3.9/2.7	4.6/2.7
MOTOR TYPE	Brushless	Brushless	Brushless	Brushless	Brushless
NOISE RATING LpA/LwA	75dB(A) 93dB(A)	69dB(A) 89dB(A)	79.3dB(A) 93dB(A)	82.6dB(A) 96dB(A)	77dB(A) 90dB(A)
DOMESTIC WARRANTY	5 years	5 years	5 years	5 years	5 years
PROFESSIONAL WARRANTY	1 year	1 year	1 year	2 years	1 year
AVAILABLE AS A KIT	ST1301E-S: Includes line trimmer, 2.5Ah battery and standard charger	ST1401E-ST: Includes line trimmer, 2.5Ah battery and standard charger	ST1511E: Includes line trimmer, 2.5Ah battery and standard charger	–	ST1613E-T: Includes line trimmer, 4.0Ah battery and standard charger

*Run time may vary and depend on the battery used, charge level of battery, condition of grass and user's operation technique. **Please refer to pages 30-31 for more information.
● - highlighted cutting area is optimal for battery.



BC3800E
30/38CM BRUSH CUTTER / LINE TRIMMER

The three-sided blade and brushless motor has the power to clear virtually any ground. Can be used as either a brush cutter or line trimmer.



- 30CM CUTTING WIDTH
- 38CM CUTTING WIDTH
- VARIABLE SPEED
- 2.4MM LINE DIAMETER
- BUMP LINE FEED
- ANY INSERT HEAD
- USE WITH EGO POWER+ BACKPACK
- CAN BE USED WITH ROTOCUT

	BC3800E
CUTTING WIDTH	
- Three-sided blade	30cm
- Line trimmer head	38cm
TOTAL LENGTH	186cm
RUN TIME*	2.5Ah Up to 20 mins 4.0Ah Up to 32 mins 5.0Ah Up to 40 mins 6.0Ah Up to 50 mins 7.5Ah Up to 65 mins 10.0Ah Up to 80 mins 12.0Ah Up to 96 mins
BLADE MATERIAL	Three-sided steel blade
SPEED CONTROL	Constant variable speed
LINE DIAMETER SUPPLIED**	2.4mm
LINE FEED	Rapid reload bump feed head
ROTATING DIRECTION	Anti clockwise
WEIGHT WITHOUT BATTERY	
- Three-sided blade	4.6kg
- Line trimmer head	4.4kg
VIBRATION (M/S²)	
- Three-sided blade	1.5/1.9
- Line trimmer head	2.3/2.4
MOTOR TYPE	Brushless
NOISE RATING LpA/LwA	80dB(A) 96dB(A)
DOMESTIC WARRANTY	5 years
PROFESSIONAL WARRANTY	2 years

*Run time may vary and depend on the battery used, charge level of battery, condition of grass and user's operation technique. **Please refer to pages 68-69 for more information.



CUT WITH POWER AND PROTECTION

The EGO Professional-X Rotocut attachment cuts through grass, weeds and moss on concrete, pathways, and verges with ease.

Featuring two counter-rotating blades instead of line, Rotocut maximises run-time and reduces vibration. Most importantly, it prevents debris from being thrown, making it ideal for use in built-up areas where risk of damage or injury can be acute. With a low profile on the gear box, it can take on the most difficult-to-reach areas.

The base plate is mounted on bearings, increasing the overall life of the tool, and reducing pavement damage. The blades have been designed to ensure clean and accurate cutting performance whilst maintaining durability.

Rotocut can be used with any rear-motored tools or EGO line trimmer multi tools, making it the ultimate attachment for added precision and protection.

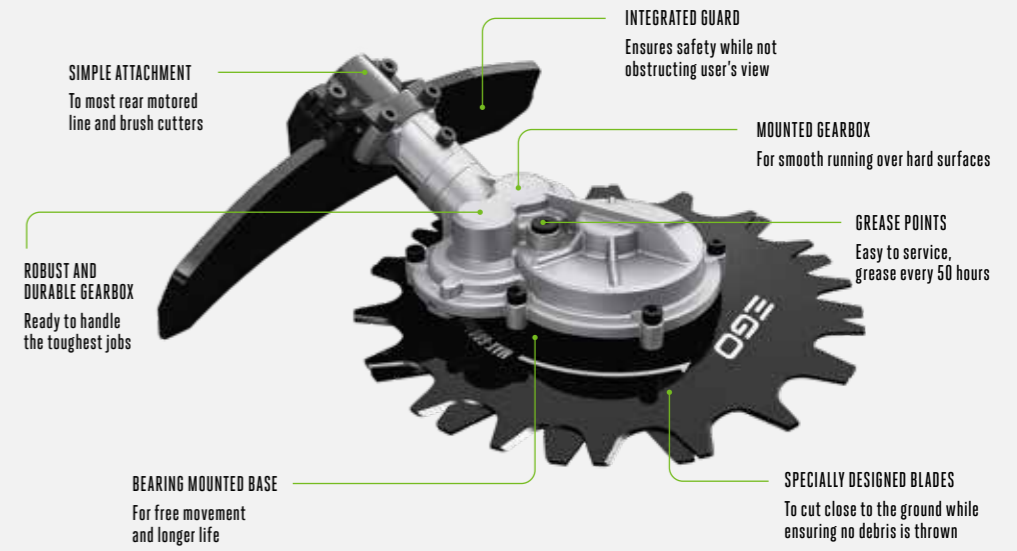

RTX2300
PROFESSIONAL-X ROTOCUT

Rotocut's flat design and simple attachment process means it can fit to most rear motor brush cutters and line trimmers on the market.

- 23CM CUTTING WIDTH
- LOW THROW

	RTX2300
CUTTING WIDTH	23cm
RUN TIME*	2.5Ah Up to 25 mins 4.0Ah Up to 40 mins 5.0Ah Up to 52 mins 6.0Ah Up to 65 mins 7.5Ah Up to 80 mins 10.0Ah Up to 105 mins 12.0Ah Up to 125 mins BAX1500 Up to 325 mins
ROTATING DIRECTION	Two blades counter rotation
BLADE TYPE	High strength alloy steel
WEIGHT	1.9kg
VIBRATION (M/S²)	1.1/1.5
NOISE RATING LpA/LwA	79.3dB(A) 93dB(A)
CUTTING SPEED	450rpm
COMPATIBLE EGO TOOLS	STX3800 / BCX3800 / ST1530E / BC3800E / STA1500 / BCA1200
DOMESTIC WARRANTY	5 years
PROFESSIONAL WARRANTY	3 years

*Run time may vary and depend on the battery used, charge level of battery and user's operation technique.



EFFICIENT AND POWERFUL
BRUSHLESS MOTOR
For longer running times



VARIABLE SPEED TRIGGER
WITH SAFETY LOCK-OFF
For efficient, safe working

CARBON FIBRE DRIVE SHAFT
Won't bend and lose shape over
time, keeping vibration levels
to a minimum

RAPID RELOAD BUMP
LINE FEED HEAD
For quick, easy line
refilling and extending
the line as you work

Can be used with Rotocut see page 101

Includes three-sided blade.



BCX3800
PROFESSIONAL-X LINE TRIMMER /
BRUSH CUTTER (BIKE HANDLE)

Leave the fuss and fumes of petrol behind with this powerful, pro-standard tool. Pair up with our Professional-X backpack battery BAX1500 for all-day power and comfort.

- 38CM CUTTING WIDTH
- 30CM CUTTING WIDTH
- VARIABLE SPEED
- 2.4-3.0MM LINE DIAMETER
- CAN BE USED WITH ROTOCUT
- BUMP LINE FEED
- CARBON FIBRE
- ANY INSERT HEAD
- USE WITH EGO POWER+ BACKPACK
- COMPATIBLE WITH PRO-X HARNESS



STX3800
PROFESSIONAL-X LINE TRIMMER /
BRUSH CUTTER (LOOP HANDLE)

Our Professional-X line trimmer provides the same power and performance as petrol. Now with a quick adjustable handle, pair up with our Professional-X backpack battery BAX1500 for all-day power and comfort.

- 38CM CUTTING WIDTH
- 30CM CUTTING WIDTH
- VARIABLE SPEED
- 2.4-3.0MM LINE DIAMETER
- CAN BE USED WITH ROTOCUT
- BUMP LINE FEED
- CARBON FIBRE
- ANY INSERT HEAD
- USE WITH EGO POWER+ BACKPACK
- COMPATIBLE WITH PRO-X HARNESS

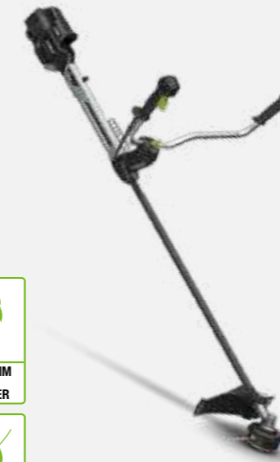

THE TOUGH ANSWER TO ROUGH GROUND

Perfectly balanced for comfortable use, EGO's Professional-X line trimmers / brush cutters make short work of even the roughest ground with the ready-for-anything 2KW motor.

Light yet strong, the solid steel drive shaft is housed in a carbon fibre drive tube. Unlike alloy shafts, it won't bend and lose its shape over time, keeping vibration levels to a minimum.

	BCX3800		STX3800	
CUTTING WIDTH				
- Line trimmer head	38cm		38cm	
- Three-sided blade	30cm		30cm	
TOTAL LENGTH	186cm		186cm	
RUN TIME* WITH BAX1500 BATTERY	With trimmer head Up to 300 mins	With brush cutter head Up to 420 mins	With trimmer head Up to 300 mins	With brush cutter head Up to 420 mins
BLADE MATERIAL	Three-sided steel blade		Three-sided steel blade	
SPEED CONTROL	Constant variable speed		Constant variable speed	
NO LOAD SPEEDS	5800rpm		5800rpm	
SOFT-START	Yes		Yes	
LINE DIAMETER SUPPLIED**	2.4mm		2.4 mm	
LINE FEED	Manual wind bump feed head		Manual wind bump feed head	
DUAL LINE	Yes		Yes	
ROTATING DIRECTION	Anti clockwise		Anti clockwise	
AUXILIARY HANDLE	Bike handle		Quick adjustable loop handle	
HARNESS	Hip pad (AHP1500)		-	
WEIGHT	6.8kg	6.5kg	6.5kg	6.2kg
MOTOR TYPE	Brushless		Brushless	
	With trimmer head	With brush cutter head	With trimmer head	With brush cutter head
NOISE RATING LpA/LwA	81dB(A) 94dB(A)	83dB(A) 96dB(A)	81dB(A) 94dB(A)	83dB(A) 96dB(A)
VIBRATION (M/S²)	1.9/1.5	1.9/1.3	2.3/1.5	1.9/4.3
DOMESTIC WARRANTY	5 years		5 years	
PROFESSIONAL WARRANTY	3 years		3 years	

*Run time may vary and depend on the battery used, charge level of battery, condition of grass and user's operation technique.
**Please refer to pages 68-69 for more information.

LINES, BLADES AND ACCESSORIES TO SUIT EVERY JOB

EGO have a range of lines, blades and harnesses to suit any trimming or cutting job, plus a range of replacement cutting heads for all EGO Line Trimmer products.

Lines for Line Trimmers

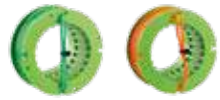

Choose a smaller line thickness for clearing long grass and lighter vegetation, or a larger, more durable line thickness for cutting down heavier, dense vegetation. Commercial, more powerful Line Trimmers are more suitable for the heavier lines, while twisted lines are quieter during use. For simple line replacement - choose a pre-wound spool for compatible tools. See our simple guide to choosing the right line below.

Brush Cutting Blades



For cutting down heavier vegetation, bushes and verges, choose a Brush Cutting blade - available in metal and flexible plastic options, depending on how heavy the task is. The flexible Elastoblade will make lighter work of dense vegetation.

Rotocut Blades



Replacement Rotocut blades will fit the EGO Power+ Rotocut attachments, which are ideal for working through tough-to-shift growth in paths and drives, and along the base of walls and curbs.

Cutting Heads



Replacement cutting heads are available for EGO Line Trimmer machines with standard, bump-feed, Powerload™ and Line IQ™ heads.

Straps and Harnesses



A full range of replacement straps and harnesses are available for EGO Line Trimmer machines, to make tackling the job easier.

Choosing the CORRECT line or blade for the job:

GRASS AND LIGHT VEGETATION	HEAVY DENSE VEGETATION	BUSHES, PATHWAYS & VERGES
<p>ROUND AND TWISTED LINES 2.0MM - 2.4MM</p>		
<p>ROUND AND TWISTED LINES 2.4MM - 3.0MM</p>		
	<p>BRUSH CUTTER BLADES METAL BLADE</p>	
	<p>BRUSH CUTTER BLADES ELASTOBLADE</p>	
		<p>ROTOCUT BLADES METAL BLADE</p>

PART	DESCRIPTION	ST1300E	ST1400E-ST	ST1500E-F	ST1510E	ST1530E	ST1610E-T	BC1500E-F	BC3800E	BCX3800	STX3800	STA1500	STA1600	BCA1200	RTA2300
ROTOCUT															
RTX2300	Professional-X Rotocut Attachment														
ABR2300	Replacement blades (pair) - ROTO CUT RTX2300														
TRIMMER SPOOLS (WITH LINE)															
AS1300	Spool with 2.4mm twist line for standard bump feed cutting head - ST1500E, BC1500E														
AS1302	Spool with 2.0mm twist line for standard bump feed cutting head - ST1300E														
AS3800	Spool w/o line for bump feed cutting head - BCX3800, STX3800														
TRIMMER LINE															
AL2415T	15m 2.4mm low-noise twist line (STRATUS)														
AL2015T	15m 2.0mm low-noise twist line (STRATUS)														
AL2050T	50m 2.0mm twist line - ST1300E (green)														
AL2715T	15m 2.7mm twist line [red/green] - STX3800, BCX3800														
AL3012T	12m 3.0mm twist line [yellow/green] - STX3800, BCX3800														
AL2475T	75m 2.4mm twist line [orange/green] - ALL 35cm & 38cm cutting diameter grass trimmers														
AL2760T	60m 2.7mm twist line [red/green] - STX3800, BCX3800														
AL3050T	50m 3.0mm twist line [yellow/green] - STX3800, BCX3800														
AL2415R	15m 2.4mm round line [orange] - ALL 35cm & 38cm cutting diameter grass trimmers														
AL2715R	15m 2.7mm round line [red] - STX3800, BCX3800														
AL3012R	12m 3.0mm round line [yellow] - STX3800, BCX3800														
AL2490R	90m 2.4mm round line [orange] - ALL 35cm & 38cm cutting diameter grass trimmers														
AL2780R	80m 2.7mm round line [red] - STX3800, BCX3800														
AL3060R	60m 3.0mm round line [yellow] - STX3800, BCX3800														
AL2416P	4 x 4.0m 2.4mm Pre-cut twisted line [black/ orange] - ST1400E-ST, ST1510E														
CUTTING HEADS															
AH1520	Powerload™ cutting head - ST1510E														
AH1522	Powerload™ cutting head - ST1400E-ST														
AH1530	ANY INSERT cutting head - CLOCKWISE - ST1500E-F, BC1500E-F														
AH1531	ANY INSERT cutting head - ANTI-CLOCKWISE - ST1530E, BC3800E, STA1500														
AH1600	Powerload™ cutting head - STA1600														
AH1620	Powerload™ cutting head - ST1610E-T														
AH3800	Bump feed cutting head - STX3800, BCX3800														
AH3810	ANY INSERT cutting head - ANTI-CLOCKWISE - ST1530E, BC3800E, STX3800, BCX3800, STA1500, BCA1200														
ABT3800	Bump feed button - AH3800														
CUTTING BLADES															
ABB1203	3 point brush cutter blade - STX3800, BCX3800, ST1530E, BC3800, BCA1200														
ABB0903P	Elastoblade - STX3800, BCX3800, ST1530E, BC3800, BCA1200														
STRAPS AND HARNESSES															
AP1500	Single-shoulder harness with one hook - multi-tool and all grass trimmers.														
AP1500D	Double-shoulder harness with guard pad - multi-tool & all grass trimmers except BCX3800 & STX3800 (cannot be used with BH1000 or BHX1000)														
AHP1300	Leg protector / line trimmer harness attachment - Only to be used with AFH1300, BH1000														
AHP1500	Leg protector / line trimmer harness attachment - Only to be used with AFH1500, BHX1000														

● = Line supplied ○ = Compatible with

EGO™
POWER+ HEDGE TRIMMER

LIGHT, YET POWERFUL. OUR NEXT GENERATION OF
CORDLESS HEDGE TRIMMERS GIVE YOU ALL THE COMFORT
AND CONTROL YOU NEED TO GET THE JOB DONE.





POWERFUL MOTOR
2400 spm 2.0Ah battery

COMFORTABLE GRIP
Excellent comfortable
controls for easy use

GRASS TRIMMER ATTACHMENT
Quick and easy edge trimming -
11.5cm cutting width

12V LITHIUM-ION BATTERY

SIMPLE ATTACHMENT
For different blade sets

HEDGE SHRUB SHEAR ATTACHMENT
Easy to change 20cm laser cut blade
with 8mm blade gap



**CHT2001E
12V SHRUB/GRASS SHEARS**

Single speed 20cm blade length, 8mm blade gap with single knife edge cutting action. Can be used as either shrub or grass shears.

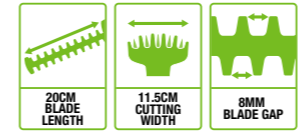

COMPACT WITHOUT COMPROMISE

They may be compact, but they don't compromise on power. Brought to life by a 12V Lithium-Ion battery, the EGO Power+ shrub/grass shears are ideal for everyday garden maintenance.

With two attachments included, use the shrub blade to shape and maintain smaller hedges and ornamental trees, or switch to the grass trimmer blade to tackle areas of grass that mowers can't reach.

A lightweight, ergonomic design allows for unparalleled precision in either mode, so you can get the perfect result every time.

Simple to use and easy to store, they are an essential addition to every gardener's arsenal.

Model Shown: CHT2001E

	CHT2001E
GRASS CUTTER BLADE WIDTH	11.5cm
HEDGE TRIMMER BLADE LENGTH	20cm
HEDGE TRIMMER BLADE GAP	8mm
RUN TIME	Up to 70 mins
SPEED CONTROL	Single-speed
NO LOAD SPEEDS	2400 spm
BLADE TYPE	Laser cut
CUTTING ACTION	Dual action; single-sided cutting blade
BLADE TIP PROTECTOR	No
STANDARD BATTERY	2.0Ah
CHARGE TIME	3.5 hours
WEIGHT WITH BATTERY	1.1kg
DOMESTIC WARRANTY	5 years
PROFESSIONAL WARRANTY	-



BALANCED, PRECISE, POWERFUL

Engineered to deliver impressive cutting ability from a single charge, the EGO Power+ Hedge Trimmer's well-balanced design and clever features makes working outdoors easier and more comfortable.

The rotating handle and dual trigger system provide enhanced user comfort and safety. While the smooth and quiet brushless motor and gearbox gives you all the power you need, without the vibration, emissions and noise of a petrol engine.

EGO hedge trimmer blades are diamond ground and double sided for clean, precise cutting. All blades have large cutting capacities for tackling thicker hedges and are available in 51cm to 66cm lengths, to suit every size of hedge. Blade-tip protection stops damage from fences and walls.

For safer working, the safety blade guard helps prevent injuries while the electric brake stops the blades when the trigger is released.

Model Shown: HT2600E



LASER CUT, DIAMOND GROUND, DOUBLE-SIDED CUTTING BLADES
Cleaner, more precise cutting



ELECTRIC SAFETY BRAKE
Stops blade when trigger is released



TWO-SPEED SELECTOR
Select the correct speed for each trimming task



SAFETY BLADE GUARD
Helps prevent injuries



ROTATING REAR HANDLE
Adjustable for comfort and control in use



BLADE TIP PROTECTOR
Prevents blades becoming damaged by fences and walls



DUAL ACTION BLADES
For less vibration when cutting

LARGE CUTTING CAPACITY
For tackling thicker hedges and large branches

Please note: some features are not available on all models.

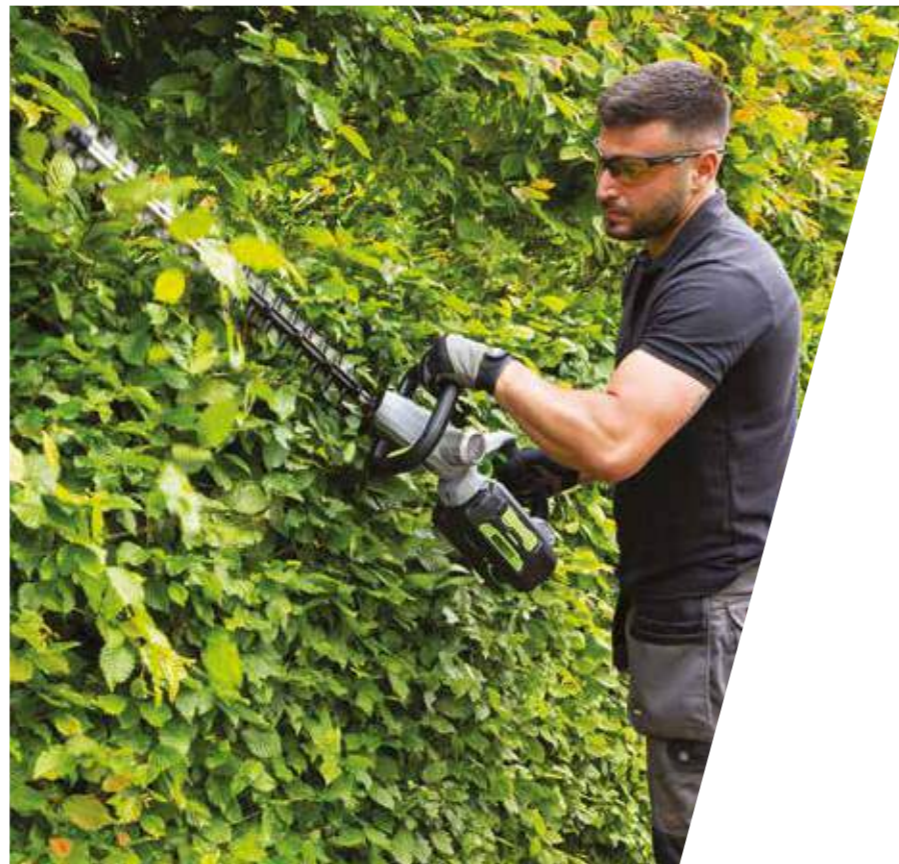

HT2000E
51CM HEDGE TRIMMER

Single-speed, single knife-edge cutting action, powerful brushless motor, ideal for cutting narrower small-to-medium hedges with thick stem widths.

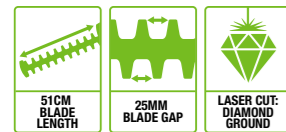

AVAILABLE AS A KIT



HT2410E
61CM HEDGE TRIMMER

Single-speed, single knife-edge cutting action, powerful brushless motor, ideal for cutting wider medium hedges with thick stem widths.

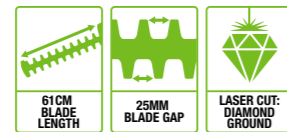

AVAILABLE AS A KIT



NEW FOR 2023

HT2600E
66CM HEDGE TRIMMER

Designed with a durable 66cm diamond ground blade and innovative rotating handle, the HT2600E provides cutting precision with ease.

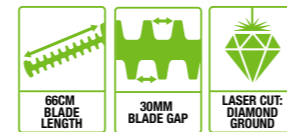

AVAILABLE AS A KIT



HT5100E
51CM HEDGE TRIMMER

Two-speed, double knife-edge cutting action, adjustable rotating rear handle for additional control, ideal for cutting narrower/long hedges with thicker stem widths.

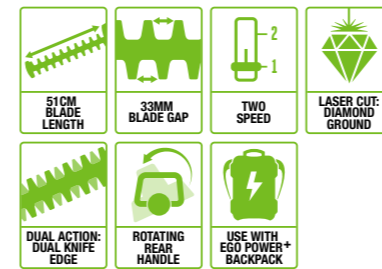

HT6500E
65CM HEDGE TRIMMER

Two-speed, double knife-edge cutting action, adjustable rotating rear handle for additional control, ideal for cutting wider/long hedges with thicker stem widths.

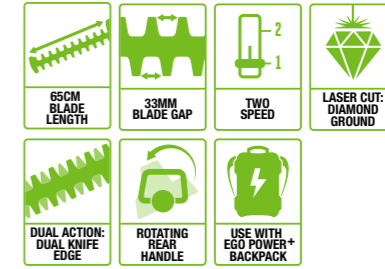

	HT2000E	HT2410E	HT2600E	HT5100E	HT6500E
BLADE LENGTH	51cm	61cm	66cm	51cm	65cm
BLADE GAP	25mm	26mm	30mm	33mm	33mm
BLADE TOOTH DEPTH	20mm	20mm	20mm	20mm	20mm
RUN TIME*	2.5Ah Up to 75 mins 4.0Ah Up to 120 mins 5.0Ah Up to 150 mins 6.0Ah Up to 210 mins 7.5Ah Up to 225 mins 10.0Ah Up to 300 mins 12.0Ah Up to 360 mins	2.5Ah Up to 75 mins 4.0Ah Up to 120 mins 5.0Ah Up to 150 mins 6.0Ah Up to 180 mins 7.5Ah Up to 225 mins 10.0Ah Up to 300 mins 12.0Ah Up to 360 mins	2.5Ah Up to 60 mins 4.0Ah Up to 90 mins 5.0Ah Up to 120 mins 6.0Ah Up to 145 mins 7.5Ah Up to 180 mins 10.0Ah Up to 240 mins 12.0Ah Up to 270 mins	2.5Ah Up to 40 mins 4.0Ah Up to 70 mins 5.0Ah Up to 82 mins 6.0Ah Up to 100 mins 7.5Ah Up to 125 mins 10.0Ah Up to 164 mins 12.0Ah Up to 195 mins	2.5Ah Up to 33 mins 4.0Ah Up to 60 mins 5.0Ah Up to 72 mins 6.0Ah Up to 90 mins 7.5Ah Up to 110 mins 10.0Ah Up to 144 mins 12.0Ah Up to 170 mins
SPEED CONTROL	Single speed	Single speed	Single speed	Two-speed	Two-speed
NO LOAD SPEEDS	3,000spm	3,000spm	3,400spm	2,800/3,200spm	2,800/3,200spm
BLADE TYPE	Laser cut; diamond ground	Laser cut; diamond ground	Laser cut; diamond ground	Laser cut; diamond ground	Laser cut; diamond ground
CUTTING ACTION	Dual action; single knife edge	Dual action; single knife edge	Dual action, single knife edge	Dual action; double knife edge	Dual action; double knife edge
BLADE TIP PROTECTOR	Yes	Yes	Yes	Yes	Yes
NOISE RATING LpA/LwA	81dB(A) 94dB(A)	83dB(A) 96dB(A)	84dB(A) 94dB(A)	81dB(A) 92dB(A)	81.4dB(A) 93dB(A)
ROTATING HANDLE	No	No	45° and 90° left and right	45° and 90° left and right	45° and 90° left and right
WEIGHT WITHOUT BATTERY	2.8kg	3kg	3.1kg	3.6kg	3.8kg
MOTOR TYPE	Brushless	Brushless	Brushless	Brushless	Brushless
VIBRATION (M/S²)	2/1.5	1.8/1.7	2.4/1.7	3.4/1.9	5.3/3.1
DOMESTIC WARRANTY	5 years	5 years	5 years	5 years	5 years
PROFESSIONAL WARRANTY	1 year	1 year	1 year	2 years	2 years
AVAILABLE AS A KIT	HT2001E: Includes hedge trimmer, 2.5Ah battery and standard charger	HT2411E: Includes hedge trimmer, 2.5Ah battery and standard charger	HT2601E: Includes hedge trimmer, 2.5Ah battery and standard charger	-	-

*Run time may vary and depend on the battery used, charge level of battery, condition of hedge and user's operation technique.

†Available on selected models.

• - highlighted cutting area is optimal for battery.



HTX6500
65CM PROFESSIONAL-X HEDGE TRIMMER

Variable speed, double-knife edge cutting action makes light work of any job, big or small. Dual trigger system provides enhanced user comfort and safety.

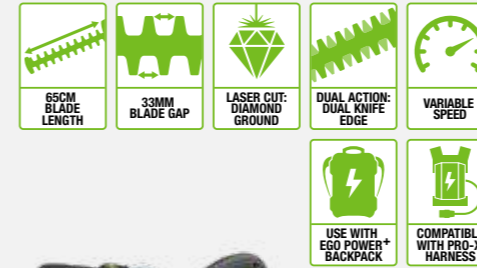

HTX7500
75CM PROFESSIONAL-X HEDGE TRIMMER

Ideal for wider, larger hedges, the variable speed, double-knife edge cutting action makes light work of any garden job. Dual trigger system provides enhanced user comfort and safety.

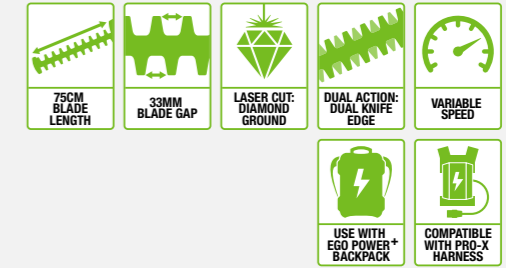

TACKLE TOUGH HEDGES WITH EASE

Designed for professionals, the Professional-X hedge trimmers are precision engineered to tackle the toughest hedges with ease.

A single charge delivers impressive run times, while the smooth and quiet brushless motor and gearbox give you all the power you need, without the vibration, emissions and noise of a petrol engine.

Blades that cut cleanly.

The high-quality EGO Power+ blades are made from laser-cut steel with diamond-ground edges to provide the cleanest cut and promote healthier hedges.



DUAL TRIGGER SYSTEM
For safe operation



LASER CUT DIAMOND GROUND BLADES



UNIQUE HANDLE AND TRIGGER DESIGN
For switching effortlessly between horizontal and vertical cutting

LOW CUTTER GUARD
For safe and easy access

65CM/75CM BLADE LENGTH WITH 33MM CUTTING CAPACITY

BLADE TIP PROTECTOR
Prevents blades becoming damaged by fences and walls

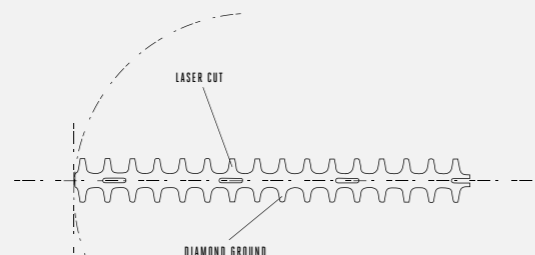

	HTX6500	HTX7500
BLADE LENGTH	65cm	75cm
BLADE GAP	33mm	33mm
BLADE TOOTH DEPTH	20mm	20mm
RUN TIME* WITH BAX1500 BATTERY	Up to 420 mins	Up to 380 mins
SPEED CONTROL	Variable speed	Variable speed
NO LOAD SPEEDS	3200spm	3200spm
BLADE TYPE	Double-sided cutting	Double-sided cutting
CUTTING ACTION	Dual action; double knife edge	Dual action; double knife edge
BLADE TIP PROTECTOR	Yes	Yes
ROTATING HANDLE	No	No
WEIGHT	3.9kg	4.0kg
MOTOR TYPE	Brushless	Brushless
NOISE RATING LpA/LwA	80 dB(A) 90.1 dB(A)	83.9 dB(A) 95.4 dB(A)
VIBRATION (M/S ²)	3.2/3.9	2.9/3.5
DOMESTIC WARRANTY	5 years	5 years
PROFESSIONAL WARRANTY	3 years	3 years

*Run time may vary and depend on the battery used, charge level of battery, condition of hedge and user's operation technique.

EGO[™]
POWER⁺ BLOWER

WITH EXCEPTIONAL AIRSPEEDS AND HIGH-EFFICIENCY BRUSHLESS MOTORS, EGO POWER⁺ BLOWERS DELIVER MAXIMUM AIRFLOW WITH MINIMUM EFFORT.





BLOWS PETROL-POWERED BLOWERS OUT OF THE PARK

Powered by a high-efficiency brushless motor, EGO Power+ blowers feature jet turbine technology and a large diameter tube to give maximum airflow.

Significantly quieter and with zero emissions, the EGO range of blowers offer a genuine alternative to petrol power.

Designed to keep you in control - from low speed, low volume airflow for those delicate areas, to high speed, high volume airflow for hard-to-shift wet leaves and objects. With more power than most handheld petrol blowers on the market, that's more than enough to clear up even the biggest windfall.



VARIABLE SPEED CONTROL
Adjust between 440m³/h and 675m³/h output



BOOST MODE
For a 986m³/h petrol-blower beating output



FLAT NOZZLE ATTACHMENT
Ideal for wet leaves



LARGE BLOWER TUBE
Greater diameter delivers maximum airflow

TURBINE FAN ENGINEERING
Utilises advanced aeronautics technology

HIGH-EFFICIENCY BRUSHLESS MOTOR
Delivers more power and greater run time



Please note: some features are not available on all models.



Compatible with EGO Power+ backpack batteries.

KEY ■ EGO POWER ■ PROFESSIONAL ■ PROFESSIONAL-X

	LB5300E			LB5800E			LB7650E			LBX6000	
	LOW SPEED	HIGH SPEED	BOOST	LOW SPEED	HIGH SPEED	BOOST	LOW SPEED	HIGH SPEED	BOOST		
RUN TIME* WITH 2.5Ah BATTERY	Up to 75 mins	Up to 22 mins	Up to 10 mins	Up to 100 mins	Up to 15 mins	Up to 9 mins	Up to 30 mins	Up to 13 mins	-	-	-
RUN TIME* WITH 4.0Ah BATTERY	Up to 120 mins	Up to 35 mins	Up to 16 mins	Up to 160 mins	Up to 24 mins	Up to 14 mins	Up to 120 mins	Up to 20 mins	Up to 14 mins	Up to 36 mins	
RUN TIME* WITH 5.0Ah BATTERY	Up to 150 mins	Up to 44 mins	Up to 20 mins	Up to 200 mins	Up to 30 mins	Up to 18 mins	Up to 150 mins	Up to 25 mins	Up to 17 mins	Up to 60 mins	
RUN TIME* WITH 6.0Ah BATTERY	Up to 180 mins	Up to 53 mins	Up to 24 mins	Up to 240 mins	Up to 36 mins	Up to 22 mins	Up to 180 mins	Up to 30 mins	Up to 18 mins	Up to 75 mins	
RUN TIME* WITH 7.5Ah BATTERY	Up to 225 mins	Up to 66 mins	Up to 30 mins	Up to 300 mins	Up to 45 mins	Up to 27 mins	Up to 225 mins	Up to 37 mins	Up to 26 mins	Up to 90 mins	
RUN TIME* WITH 10.0Ah BATTERY	Up to 300 mins	Up to 88 mins	Up to 40 mins	Up to 400 mins	Up to 60 mins	Up to 36 mins	Up to 300 mins	Up to 50 mins	Up to 34 mins	Up to 120 mins	
RUN TIME* WITH 12.0Ah BATTERY	Up to 360 mins	Up to 105 mins	Up to 48 mins	Up to 480 mins	Up to 72 mins	Up to 36 mins	Up to 360 mins	Up to 60 mins	Up to 40 mins	Up to 145 mins	
RUN TIME* WITH BAX1500 BATTERY	-	-	-	-	-	-	-	-	-	Level 1	Up to 350 mins
										Level 2	Up to 210 mins
										Level 3	Up to 140 mins
										Level 4	Up to 100 mins
										Boost	Up to 70 mins
	Max			Max			Max				
AIR VOLUME (M ³ /H)	900			986			1300			1014m ³ /h Max	
AIR SPEED (KM/H)	176			270			313			212km/h	
FORCE (N)	16			18			26			19.2 Max	
SPEED SETTING	Variable speed with boost			Constant variable speed with lock-on + boost			Variable speed with lock-on + boost			4 level settings and boost	
WEIGHT WITHOUT BATTERY	2.2kg			2.2kg			2.1kg			2.7kg	
MOTOR TYPE	Brushless			Brushless			Brushless			Brushless	
NOISE RATING LpA/LwA	82 dB(A) 100dB(A)			78.4 dB(A) 95 dB(A)			83dB(A) 98dB(A)			80 dB(A) 93dB(A)	
VIBRATION (M/S ²)	1.35			0.18			0.8			1.2	
DOMESTIC WARRANTY	5 years			5 years			5 years			5 years	
PROFESSIONAL WARRANTY	1 year			2 years			2 years			3 years	
CONSTANT SPEED	-			-			-			Yes	
AVAILABLE AS A KIT	LB5301E: Includes blower, 2.5Ah battery and standard charger			LB5804E: Includes blower, 5.0Ah battery and fast charger			-			-	

*Run time may vary and depend on the battery used, charge level of the battery and user's operation technique.
● - highlighted run time is optimal for battery.



**LB5300E
BLOWER**

Variable speed setting, large blower tube, up to 900m³/h output in Boost, for clearing small to medium-sized spaces.



Includes AN5300 Flat Nozzle.

AVAILABLE AS A KIT



**LB7650E
BLOWER**

Variable speed thumb selector for added airflow control with single handed use, 1,300m³/h output in Boost - by far the industry's most powerful hand-held blower, outperforms even the leading petrol-powered blowers. Perfect for completing the toughest tasks across wider areas and large gardens.



Includes AN6000R (Round) and AN6000F (Flat) Nozzles.



**LB5800E
BLOWER**

Variable speed thumb selector for added airflow control with single handed use, 986m³/h output in Boost, for completing bigger tasks across wider areas and large gardens.



Includes AN6000R (Round) and AN6000F (Flat) Nozzles.

AVAILABLE AS A KIT



**LBX6000
PROFESSIONAL-X BLOWER**

Designed to be used with the Professional-X Backpack Battery BAX1500, this powerful blower is light and easy to handle. Plus, the smooth brushless motor reduces vibration and noise compared to its petrol-powered equivalents.



Includes AN6000R (Round) and AN6000F (Flat) Nozzles.





NEW FOR 2023



**LBP8000E
BACKPACK BLOWER**

Activate Peak Power™ Technology by combining the power of two EGO batteries for maximum output and runtime making clearing work faster. Designed with an improved user interface, control system and newer, more powerful motor, the LBP8000E takes comfortable, efficient working to the next level.



PEAK POWER™ TECHNOLOGY
For greater power and run time

IMPROVED INTERFACE WITH BATTERY STATUS

VARIABLE SPEED WITH SPEED LOCK AND BOOST

THE POWER TO CLEAR MORE GROUND

Tough tasks need powerful tools. And that's exactly what EGO's range of Backpack Blowers deliver. In Boost mode, leaves and debris don't stand a chance.

Not only are our Blowers powerful, they also benefit from intelligent features. The brushless motors reduce vibration and noise while the comfortable backpacks ergonomically distribute the weight of the tool. Boasting five hours run time*, you can cover plenty of ground too.



**LB6000E
BACKPACK BLOWER**

The hugely powerful, yet ergonomic design is easy to use and packed with all the features you need.



AVAILABLE AS A KIT



NEW, MORE POWERFUL AND EFFICIENT MOTOR



	LB6000E			LBP8000E		
	Low	High	Max	Low	High	Max
RUN TIME** WITH 5.0Ah BATTERY	120 mins	22 mins	15 mins	30 mins	15 mins	10 mins
RUN TIME** WITH 6.0Ah BATTERY	150 mins	27 mins	18 mins	38 mins	18 mins	12 mins
RUN TIME** WITH 7.5Ah BATTERY	180 mins	33 mins	23 mins	47 mins	22 mins	15 mins
RUN TIME** WITH 10.0Ah BATTERY	240 mins	44 mins	30 mins	63 mins	29 mins	20 mins
RUN TIME** WITH 12.0Ah BATTERY	290 mins	52 mins	36 mins	75 mins	35 mins	24 mins
AIR VOLUME (M³/H)	440	850	1020	350	650	1360
AIR SPEED (KM/H)	80	160	193	80	160	260
SPEED SETTING	Variable speed with boost			Variable speed with boost		
FORCE (N)	19.2 Max			26 Max		
MOTOR TYPE	Brushless			Brushless		
NOISE RATING LpA/LwA	83dB(A) 97dB(A)			86dB(A) 98dB(A)		
VIBRATION (M/S²)	1.5			1.5		
WEIGHT WITHOUT BATTERY	5.7kg			7.4kg		
DOMESTIC WARRANTY	5 years			5 years		
PROFESSIONAL WARRANTY	2 years			2 years		
AVAILABLE AS A KIT	LB6002E: Includes backpack blower, 5.0Ah battery and rapid charger LB6000E-K1103: Includes backpack blower, 10.0Ah battery and rapid charger			-		

**Run time may vary and depend on the battery used, charge level of battery and user's operation technique.
- highlighted run time is optimal for battery.

EGO
POWER+ SNOW THROWER

WITH PEAK POWER™ TECHNOLOGY, THE EGO SNOW THROWERS PROVIDE PETROL-MATCHING POWER TO CLEAR SNOW WITH EASE.



EXTREME POWER FOR EXTREME WEATHER CONDITIONS

EGO's Power+ Professional Stage Snow Throwers use Peak Power™ Technology to deliver petrol-matching performance without noise, fuss or emissions.

Peak Power™ Technology combines the power of any two industry-leading EGO 56V ARC Lithium™ batteries to tackle the toughest snowy conditions efficiently. Variable-speed self-propelled control ensures ease of use. Reverse gears and wheel drive systems make getting out of tight spots easier.

NEW FOR 2023

SNT2120E-AP AUGER PROPELLED SNOW THROWER

The SNT2120E-AP can clear 21cm of snow and throw it up to 14 metres, making it ideal for those early morning clearing jobs along driveways and footpaths.

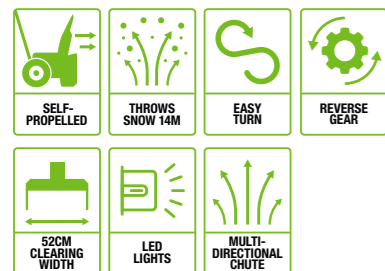

THROWS SNOW UP TO 14M
Multi-directional chute, remotely controlled

ADJUSTABLE CHUTE
Allowing snow to be thrown in any direction

EASY-TO-USE CONTROL PANEL
For self-propel speed and snow throwing

LED LIGHTS
For enhanced visibility

ADJUSTABLE HANDLE HEIGHT

FOLDING ALUMINIUM HANDLES
For compact storage

TREADED REAR WHEELS
For increased traction and easy transport

RUBBERISED AUGER
Providing traction allowing the Snow Thrower to be pulled along while clearing



SNT2400E 61 CM SELF-PROPELLED 2-STAGE SNOW THROWER WITH PEAK POWER™ TECHNOLOGY

Peak Power™ Technology delivers maximum power to handle even the deepest snow with ease. The generous 61cm clearing width and 51cm intake height work with the multi-directional shoot for a clearing distance of up to 13m, while the on-board controls are easy to operate - even when wearing bulky winter gloves.



	SNT2120-AP	SNT2400E
CLEARING AREA @ 15CM DEPTH	160m ²	223m ²
NUMBER OF BATTERY PORTS	2 parallel	2 parallel
CLEARING WIDTH	52cm	61cm
INTAKE HEIGHT	30cm	51cm
CHUTE ROTATION	180°	200° Joystick control
THROWING DISTANCE (MAX)	Up to 14m	13m
THROWING DISTANCE (HEAVY SNOW)	5m	7.6m
AUGER MATERIAL & DIAMETER	Metal frame/rubber auger 18cm	Steel 28cm
NUMBER OF STAGES	1	2
SELF-PROPELLED SPEED	Single	0.4-1.2m/s
SELF-PROPEL TYPE	Auger propel	-
REVERSE	Yes	Yes
WEIGHT WITHOUT BATTERY	27kg	68kg
MOTOR TYPE	Brushless	Brushless
DOMESTIC WARRANTY	5 years	5 years
PROFESSIONAL WARRANTY	1 year	2 years
AVAILABLE AS A KIT	SNT2124E-AP: Includes snow thrower, 2x 6Ah batteries and rapid+ charger	SNT2400E-K2753: Includes snow thrower, 2x 7.5Ah batteries and 2x rapid+ chargers

EGO[™]
POWER⁺ MULTI-TOOL

WE'VE REDEFINED FLEXIBLE WORKING. CUT, SAW,
EDGE AND MORE. ALL WITH ONE POWER UNIT AND
ALL WITHOUT THE FUSS AND FUMES OF PETROL.



ONE TOOL, MULTIPLE OPTIONS

The EGO Power+ Multi-Tool is the outdoor power tool you can't do without. With a single power unit and a large range of high-tech attachments, you can easily tackle every garden task, from trimming grass, edging lawns, cutting hedges, sawing branches, tilling soil, to sweeping the patio. Switching between different jobs is simple thanks to the secure tool-free coupling system on every attachment. And, with our carbon fibre extension pole, even the hardest-to-reach places are no challenge for the Multi-Tool. Combined with the 56V ARC Lithium™ battery, you have all the power you need, without the noise, fuss, or emissions of petrol-power.

New for 2023.

Power up with our new, more intelligent carbon fibre Power Head. Compatible with our latest Line Trimmer attachment and all existing Multi-Tool attachments.

NEW FOR 2023

01 EGO POWER+ HEDGE TRIMMERS

A choice of standard or short pole lengths to suit high and low hedges

02 EGO POWER+ POLE SAW

Slices through tree branches fast and efficiently

03 EGO POWER+ LINE TRIMMER

Trim grass along fences and walls with precision

04 EGO POWER+ BRUSH CUTTER

Cuts through tough undergrowth, thick grass and weeds with ease

05 EGO POWER+ ROTOCUT

Cuts through grass, weeds and moss on concrete, pathways and verges without throwing up stones and debris

06 EGO POWER+ EDGER

Achieving a perfect edge to any lawn has never been easier

07 EGO POWER+ CULTIVATOR

The simple way to prepare soil for planting

08 EGO POWER+ BRISTLE BRUSH & PADDLE BROOM

Clears moss, wet leaves and water from hard surfaces with ease

09 EGO POWER+ OLIVE SHAKER

Shake ripe olives off branches

10 EGO POWER+ SNOW SHOVEL

Keeps pathways clear of snow

11 EGO POWER+ LINE TRIMMER

With Powerload™ Technology

MULTI-TOOL POWER HEAD

Ready for any job, big or small



THE POWER TO TACKLE ANY TASK



NEW FOR 2023

PH1420E MULTI-TOOL POWER HEAD

With more power, better ergonomics and an upgraded motor the PH1420E is compatible with all current and future attachments.



PH1400E MULTI-TOOL POWER HEAD

With a powerful and smooth high-efficiency brushless motor, it's lightweight, perfectly balanced and ready for any job, big or small.

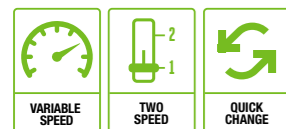

SIMPLE AND SECURE COUPLING MECHANISM
Makes switching attachments quick and easy



ADJUSTABLE LOOP HANDLE
For comfortable use

DIGITAL SPEED SELECTOR

COMPATIBLE WITH ALL EGO BATTERIES



EP7501 EXTENSION POLE

Nothing is out of reach with this strong yet lightweight extension pole. Just click in the attachment you need and off you go.



TOTAL LENGTH: 78cm
WEIGHT 600g



POWERFUL REAR MOUNTED MOTOR
Suitable for all attachments

VARIABLE SPEED TRIGGER
With 2 pre-set speeds

	PH1400E	PH1420E
MOTOR TYPE	Brushless	Brushless
SPEED CONTROL	Two speed Variable speed	Two speed Variable speed
DRIVE SHAFT MATERIAL	7mm solid steel	7mm solid steel
DRIVE TUBE TYPE	Aluminium	Carbon fibre
COUPLING MECHANISM	Tool-free quick change	Tool-free quick change
WEIGHT	2.7kg	2.8kg
TOTAL LENGTH	97cm	97cm
DOMESTIC WARRANTY	5 years	5 years
PROFESSIONAL WARRANTY	2 years	2 years

ONE REVOLUTIONARY POWER UNIT. SO MANY WAYS TO USE IT



01 HEDGE TRIMMERS

With a choice of standard or short pole lengths available, tackling high or low hedges is made easy. The head angle is adjustable to suit the job at hand and allows for compact storage.



06 EDGER

Give lawns a professional finish with the edger attachment. Ideal for neatening edges along paths, driveways or flowerbeds.



02 POLE SAW

Slices through tree branches fast and efficiently. Combines with the carbon fibre extension pole to reach further and cut more.



07 CULTIVATOR

The cultivator prepares soil prior to planting. Removing weeds and introducing air, it creates a loose bed, encouraging the growth of healthy plant life.



03 LINE TRIMMERS

Trim grass along fences and walls with precision. Includes our Rapid Reload head, making it easy to replace line.



08 BRISTLE BRUSH & PADDLE BROOM

The bristle brush makes short work of sweeping away moss, wet leaves and ingrained dirt, whilst the paddle broom makes it easy to clear away standing water.



04 BRUSH CUTTER

The brush cutter is built to deal with difficult undergrowth. From thick grass to tough weeds, it cuts through the toughest tasks with ease.



09 OLIVE SHAKER

Shake ripe olives off branches at approximately 2000 strokes per minute, with 10 replaceable carbon fibre fingers, a durable and market tested gearbox and integrated lubrication for simple maintenance.



05 ROTOCUT

Cuts through grass, weeds and moss on concrete, pathways and verges with ease. Featuring two counter-rotating blades, preventing debris from being thrown.



10 SNOW SHOVEL

The Snow Shovel is excellent for clearing snow quickly from patios, decks and driveways.



HTA2000
HEDGE TRIMMER ATTACHMENT

Laser cut, diamond ground blades and simple angle adjustment makes this trimmer as precise as it is powerful.

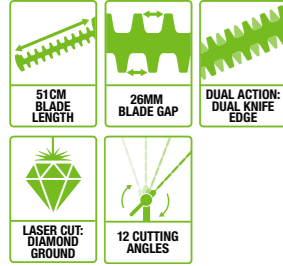

HTA2000S
SHORT HEDGE TRIMMER ATTACHMENT

With the same sharp blades and quick cutting action, this attachment makes short work of low, deep hedges.



PSA1000
POLE SAW ATTACHMENT

25cm guide bar and chain make cutting branches fast and efficient.



CTA9500
CULTIVATOR ATTACHMENT

The easier way to prepare soil for planting, the cultivator's rotating teeth remove weeds and aerates soil.



BBA2100
BRISTLE BRUSH ATTACHMENT

Clear moss and wet leaves from hard surfaces easily with the new bristle brush attachment.

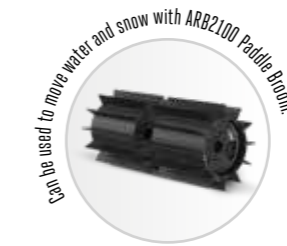

RTA2300
ROTCUT ATTACHMENT

Cuts through grass, weeds and moss with ease. Featuring two counter rotating blades, which prevent debris from being thrown, make it ideal for use in delicate areas.

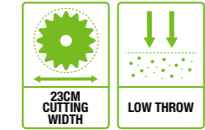

STA1500
LINE TRIMMER ATTACHMENT

This attachment is packed with features to save you time and help you work safely, quickly and efficiently.

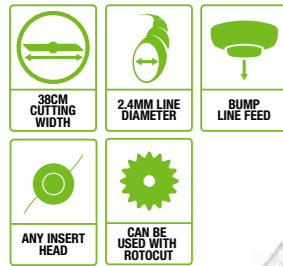

BCA1200
BRUSH CUTTER ATTACHMENT

Tough enough to take on anything, the three-sided metal blade makes short work of any overgrown area.

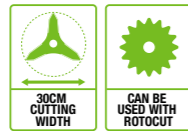

EA0800
EDGER ATTACHMENT

With quick depth adjustment and handy guide, this attachment makes achieving a perfect edge easy.



OSA1000
OLIVE SHAKER ATTACHMENT

10 carbon fibre fingers shake and drop olives from their branches in no time at all.



SSA1200
SNOW SHOVEL ATTACHMENT

The Snow Shovel is excellent for clearing snow quickly from patios, decks and driveways.



STA1600
LINE TRIMMER ATTACHMENT

This attachment is packed with features to save you time and help you work safely, quickly and efficiently. Powerload™ feature only compatible with PH1420E.

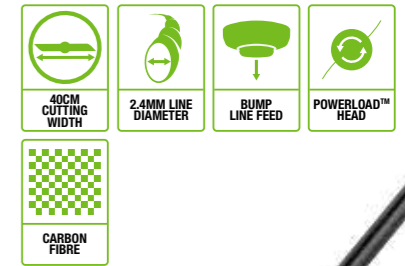

NEW FOR 2023 POWERLOAD™ TECHNOLOGY

	HTA2000 / HTA2000S	PSA1000	STA1500	STA1600	BCA1200	RTA2300
WEIGHT	2.3kg / 2.2kg	1.9kg	1.6kg	1.53kg	1.8kg	2kg
TOTAL LENGTH	160cm (99cm folded) / 120cm	142cm	97cm	185cm	102cm	-
RUN TIME*	2.5Ah Up to 37 mins 4.0Ah Up to 65 mins 5.0Ah Up to 82 mins 6.0Ah Up to 98 mins 7.5Ah Up to 122 mins 10.0Ah Up to 157 mins 12.0Ah Up to 188 mins	2.5Ah Up to 70 cuts 4.0Ah Up to 110 cuts 5.0Ah Up to 140 cuts 6.0Ah Up to 170 cuts 7.5Ah Up to 210 cuts 10.0Ah Up to 285 cuts 12.0Ah Up to 340 cuts	2.5Ah Up to 18 mins 4.0Ah Up to 35 mins 5.0Ah Up to 45 mins 6.0Ah Up to 55 mins 7.5Ah Up to 72 mins 10.0Ah Up to 93 mins 12.0Ah Up to 110 mins	2.5Ah Up to 18 min 4.0Ah Up to 35 min 5.0Ah Up to 45 min 6.0Ah Up to 55 min 7.5Ah Up to 70 min 10.0Ah Up to 90 min 12.0Ah Up to 110 min	2.5Ah Up to 27 mins 4.0Ah Up to 50 mins 5.0Ah Up to 60 mins 6.0Ah Up to 75 mins 7.5Ah Up to 95 mins 10.0Ah Up to 125 mins 12.0Ah Up to 150 mins	2.5Ah Up to 25 mins 4.0Ah Up to 40 mins 5.0Ah Up to 52 mins 6.0Ah Up to 60 mins 7.5Ah Up to 80 mins 10.0Ah Up to 105 mins 12.0Ah Up to 125 mins
BLADE LENGTH	51cm	-	-	-	-	-
CUTTING WIDTH	-	-	38cm	40cm	30cm	23cm
LINE DIAMETER SUPPLIED	-	-	2.4mm dual line	2.4mm	-	-
CUTTING HEAD	-	-	Rapid reload trimmer head	Powerload™	-	-
SHAFT TYPE	-	-	Straight	Carbon Fibre	-	-
ARBOUR SIZE	-	-	-	-	25.4mm	-
CUTTING CAPACITY	26mm	-	-	-	-	-
BLADE MATERIAL AND TYPE	Double-sided laser cut steel blade	-	-	-	Three-sided steel blade	-
FIXED CUTTING ANGLES	12 / 9 articulating cutting angles	-	-	-	-	-
GUIDE BAR LENGTH	-	25cm	-	-	-	-
CHAIN PITCH / GAUGE	-	9.5mm, 1.1mm	-	-	-	-
MAX. CUTTING DIAMETER	-	200mm	-	-	-	-
OIL TANK CAPACITY	-	220ml	-	-	-	-
ROTATING DIRECTION	-	-	-	-	-	Two blades counter rotation
BLADE TYPE	-	-	-	-	-	High strength alloy steel
VIBRATION (M/S²)	-	-	-	-	-	1.1/1.5
NOISE RATING	-	-	-	-	-	83dB(A) / 96dB(A)
CUTTING SPEED	-	-	-	-	-	450rpm
DOMESTIC WARRANTY	5 years	5 years	5 years	5 years	5 years	5 years
PROFESSIONAL WARRANTY	2 years	2 years	2 years	2 years	2 years	2 years

	EA0800	CTA9500	BBA2100	OSA1000	SSA1200
WEIGHT	2.3kg	3.9kg	5kg	2.2kg	5.5kg
TOTAL LENGTH	92cm	92cm	102cm	140cm	176cm
RUN TIME*	2.5Ah N/A 4.0Ah Up to 50 mins 5.0Ah Up to 60 mins 6.0Ah Up to 75 mins 7.5Ah Up to 100 mins 10.0Ah Up to 132 mins 12.0Ah Up to 158 mins	2.5Ah Up to 40 mins 4.0Ah Up to 60 mins 5.0Ah Up to 80 mins 6.0Ah Up to 100 mins 7.5Ah Up to 120 mins 10.0Ah Up to 160 mins 12.0Ah Up to 190 mins	2.5Ah Up to 50 mins 4.0Ah Up to 120 mins 5.0Ah Up to 120 mins 6.0Ah Up to 140 mins 7.5Ah Up to 150 mins 10.0Ah Up to 200 mins 12.0Ah Up to 280 mins	2.5Ah Up to 50 mins 4.0Ah Up to 80 mins 5.0Ah Up to 100 mins 6.0Ah Up to 120 mins 7.5Ah Up to 160 mins 10.0Ah Up to 210 mins 12.0Ah Up to 250 mins	2.5Ah Up to 45 min 4.0Ah Up to 75 min 5.0Ah Up to 90 min 6.0Ah Up to 110 min 7.5Ah Up to 135 min 10.0Ah Up to 180 min 12.0Ah Up to 216 min
BLADE LENGTH	20cm	24cm	-	-	-
ROD LENGTH / DIAMETER	-	-	-	33cm/0.5cm	-
CUTTING DEPTH	Up to 75mm	-	-	-	-
BLADE THICKNESS	3mm	-	-	-	-
ROD QUANTITY	-	-	-	10 (5+5)	-
DEBRIS GUARD MATERIAL	Aluminium with rubber skirt	Plastic	Plastic	-	-
CUTTING WIDTH	-	21/24cm	-	-	-
CLEANING SWATH	-	-	560mm	-	300mm
TILLING SPEED	-	-	High 240rpm, Low 210rpm	-	2000-1650rpm
WORKING RANGE	-	-	-	58cm-33cm	-
BRISTLE GAUGE	-	-	1.5mm	-	-
ARBOUR SIZE	25.4mm	-	-	-	-
DIMENSION	-	-	102 x 56.5 x 29.5cm	-	-
ROD MATERIAL	-	-	-	Carbon fibre	-
STROKES PER MINUTE	-	-	-	1780/2120spm	-
MAX THROWING DISTANCE	-	-	-	-	7.5m
DOMESTIC WARRANTY	5 years	5 years	5 years	5 years	5 years
PROFESSIONAL WARRANTY	2 years	2 years	2 years	2 years	2 years

*Run time may vary and depend on the battery used, charge level of battery, condition of grass or hedge and user's operation technique. Cuts of PSA1000 is based on cuts of 100x100mm.

BE READY FOR ANYTHING WITH EGO POWER+ MULTI-TOOL KITS

A great value way to enjoy all the benefits of petrol-free power. EGO Power+ multi-tool kits combine the most popular tools you'll need, with the power and performance to get the job done.

MHCC1002E MULTI-TOOL KIT

With everything you need to tackle all jobs above the ground, this kit includes the power head with hedge trimmer and pole saw attachments together with a 2.5Ah battery and rapid charger.

Includes:

- PH1400E - Power head
- HTA2000 - Hedge trimmer attachment
- PSA1000 - Pole saw attachment
- BA1400T - 2.5Ah battery
- CH5500E - Rapid charger
- AP1500 - Single-shoulder harness



MHSC2002E MULTI-TOOL KIT

Our ultimate multi-tool kit includes the power head with line trimmer, hedge trimmer, pole saw and edger attachments, along with a 5.0Ah battery and rapid charger.

Includes:

- PH1400E - Power head
- STA1500 - Line trimmer attachment
- HTA2000 - Hedge trimmer attachment
- PSA1000 - Pole saw attachment
- EA0800 - Edger attachment
- ABB1203 - Brush cutter blade
- BA2800T - 5.0Ah battery
- CH5500E - Rapid charger
- AP1500 - Single-shoulder harness



EGO[™]
POWER ⁺ LIFESTYLE

WITH SUPERIOR PORTABILITY, OUR INNOVATIVE
LIFESTYLE RANGE BRINGS INTELLIGENT
TECHNOLOGY TO THE EVERYDAY.





PORTABLE POWER WHEREVER YOU NEED IT

Compatible with any EGO ARC Lithium™ battery, the Nexus Escape provides power when and wherever you need it.

Built with a powerful 240V AC outlet and three USB ports, the Nexus Escape boasts flexible power to charge mobile phones, laptops, cameras, lights, and other electrical devices up to a maximum output of 500 Watts. Ideal for camping trips, beach visits, festivals or for use at home, the Nexus Escape is light weight and small enough to carry in a rucksack or store in a tent.



PAD1500E
150W NEXUS ESCAPE POWER INVERTER

The EGO Power+ Nexus Escape's 240V (150W) AC power outlet and 2 USB ports enable you to charge or power devices wherever you are. The light-weight design and carry handle make the device easy to transport.

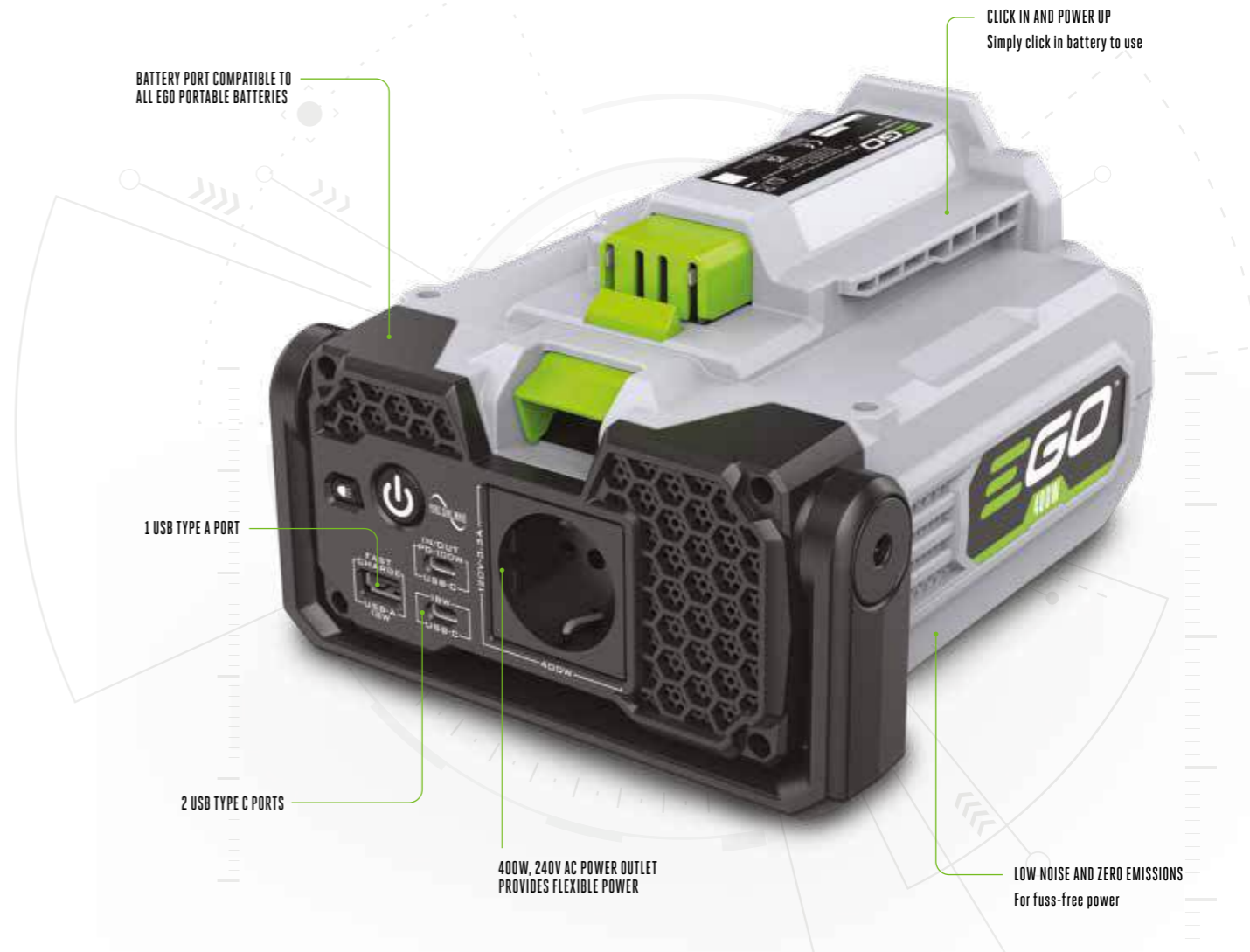

PAD5000E
500W NEXUS ESCAPE POWER INVERTER

With three USB ports of varying type and a 240V AC power outlet, the new EGO Power+ Nexus Escape is capable of charging or powering multiple power devices up to 500 Watts. The pure Sine Wave inverter makes it suitable for use with even the most sensitive electronic devices.

	PAD1500E	PAD5000E
CAPACITY	150W	500W
CONNECTION METHOD	Compatible with any EGO portable battery	Compatible with any EGO portable battery
WEIGHT WITHOUT BATTERY	0.5kg	1.6kg
DOMESTIC WARRANTY	5 years	5 years
PROFESSIONAL WARRANTY	-	-
AVAILABLE AS A KIT	PAD1501E: Includes Nexus power inverter, 2.5Ah battery and standard charger	PAD5001E: Includes Nexus power inverter and 2.5Ah battery

CAPABLE OF POWERING OR CHARGING*

*Based on 7.5Ah battery BA4200T



OUR COOLEST INNOVATION YET

NEW FOR 2023

With double the airflow of a standard 50cm fan, the EGO Power+ 45cm Misting Fan is an essential tool for warm conditions.

Complete with two misting modes: intermittent and continuous, five speed settings ranging between 700 L/s to 2350 L/s, the EGO Power+ 45cm Misting Fan has an impressive 50m² Cooling Area Capacity. With a minimal noise level of just 68 dB and up to 60 hours run time (with 5.0Ah battery) on speed one, this fan is suitable for both indoor and outdoor cooling. Its light-weight and advanced portable features make it ideal for hot working conditions, sporting events, camping trips and BBQs.



1. 50-1750 RPM BLADE ROTATION

LOW NOISE OF 68DB
When on speed one

4 EASY-TO-CLEAN MISTING NOZZLES

5 FAN SPEEDS PLUS TURBO

COMPATIBLE WITH ALL EGO PORTABLE BATTERIES

UP TO 60 HOURS RUN TIME
When on speed one with 5Ah battery

DURABLE WHEELS

2.225° ANGLE ADJUSTMENT

TELESCOPIC HANDLE
For easy transport



**FN1800E
45CM MISTING FAN**

With a Cooling Area Capacity of 50m², two misting modes, five speed settings and double the airflow of a standard 50cm fan, the EGO Power+ 45cm Misting Fan is ideal for cooling both indoor and outdoor environments.

	FN1800E
RUNTIME	2.5Ah Up to 31 hours 4.0Ah Up to 50 hours 5.0Ah Up to 63 hours 6.0Ah Up to 76 hours 7.5Ah Up to 95 hours 10.0Ah Up to 127 hours 12.0Ah Up to 152 hours
WEIGHT WITHOUT BATTERY	10.4kg
DOMESTIC WARRANTY	5 years
PROFESSIONAL WARRANTY	1 year

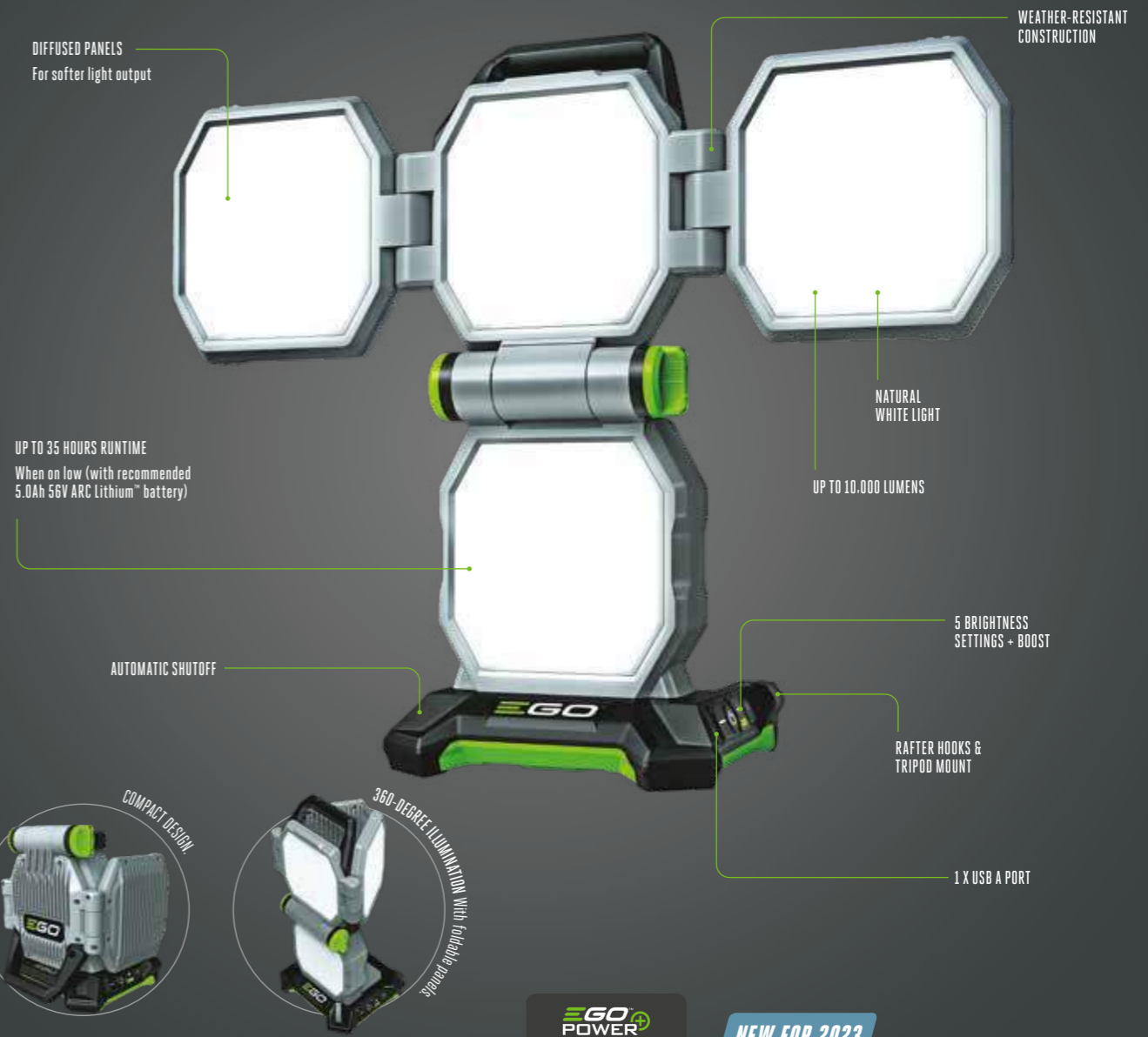

DIFFUSED PANELS
For softer light output

UP TO 35 HOURS RUNTIME
When on low (with recommended 5.0Ah 56V ARC Lithium™ battery)

WEATHER-RESISTANT CONSTRUCTION

NATURAL WHITE LIGHT

UP TO 10,000 LUMENS

5 BRIGHTNESS SETTINGS + BOOST

AUTOMATIC SHUTOFF

RAFTER HOOKS & TRIPOD MOUNT

1 X USB A PORT

COMPACT DESIGN

360-DEGREE ILLUMINATION with foldable panels

EGO POWER+ NEW FOR 2023

PORTABLE POWER MADE BRIGHTER

With adjustable power of up to 10,000 lumens, the EGO Power+ Portable Area Light is the world's most powerful cordless outdoor area light.

Tailor the light level to suit you with five brightness settings and turn up the power boost mode for maximum output. The diffused, foldable panels allow for soft 360 illumination. Transporting and storing the area light is easy thanks to its compact design and integrated handle. Charge devices on the go with the built-in USB A port. This versatile tool is perfect for ambient mood lighting, task lighting and illuminating large areas.

**LT1000E
PORTABLE AREA LIGHT**

Complete with five brightness settings, foldable panels, easy transportation and storage, the EGO Power+ Portable Area Light is suitable for everything from mood lighting to task lighting.

	LT1000E					
BRIGHTNESS LEVEL	1	2	3	4	5	BOOST
LUMINOUS FLUX/BRIGHTNESS (4 PANELS COMBINED)	600lm	1600lm	3200lm	4800lm	6400lm	10000lm
APPROXIMATE RUN TIME* (4 PANELS WITH EGO 56V 5.0 AH BATTERY)	36h	16h	8h	5h	4h	1h
WEIGHT (WITHOUT BATTERY PACK)	4.3kg					
DOMESTIC WARRANTY	5 years					
PROFESSIONAL WARRANTY	1 year					

*The light will illuminate at 10,000lm in ambient temperature 25° C for 1 hour and will run for 2 more hours in brightness level 5. Please note that the 1 hour run time is dependent on ambient temperature. In a cooler environment the "Boost" mode will have a longer run time, but in a hot environment the "Boost" mode will have a shorter run time.

CHANGE STARTS NOW

We believe that tools designed to improve our surroundings shouldn't be damaging to the wider environment.

LOOKING TO THE FUTURE

As our cause gathers momentum, we will work closely with non-governmental organizations (NGOs) and other committed partners to petition for EU parliamentary debate. To us, the case for switching from petrol to battery power is glaringly obvious and with many regions across Europe already adopting this change, we're seeing our industry changing fast.

Together, we'll create a cleaner, quieter, safer and, most importantly, greener future.

CHALLENGE 20/25

Challenge 2025 is our commitment to educate and empower outdoor power equipment users to pick the only logical choice when purchasing new gardening equipment: battery powered. It's time to leave petrol where it belongs; in the past.

Our Challenge 2025 vision is that by 2025, battery power will become the principal power source for outdoor power equipment, leading to significant reductions in harmful emissions and noise, while increasing safety and user comfort.

Our responsibility as tech leaders.

Our expertise and world-leading technology means we have a responsibility to encourage the switch from petrol to battery power and we do this by creating tools which outperform petrol in every way.

Demand better.

Demand better from the tools you use in your garden at home.

Demand better from the groundskeeping teams that maintain the areas near your offices and schools.

Demand better from your local council managing your green spaces and parks.

ZERO EMISSION

EGO battery power produces zero emissions and costs less to run and maintain than its petrol-powered equivalents.

Beyond challenge 2025.

We believe it's not just about making improvements to help the environment, but actively participating in its repair.

We have partnered with Eden Reforestation Projects and pledge to plant a tree for every EGO tool sold in Europe, as well as each tool registered for extended warranty. The Eden Reforestation Projects work with local communities across the globe to restore forests on a large scale to create jobs, protect ecosystems and help mitigate climate change.

Challenge 2025 is just one initiative, and we won't stop there.



Eden Reforestation Projects



For more information on Challenge 2025 and our five-year vision, visit our website challenge2025.eu.

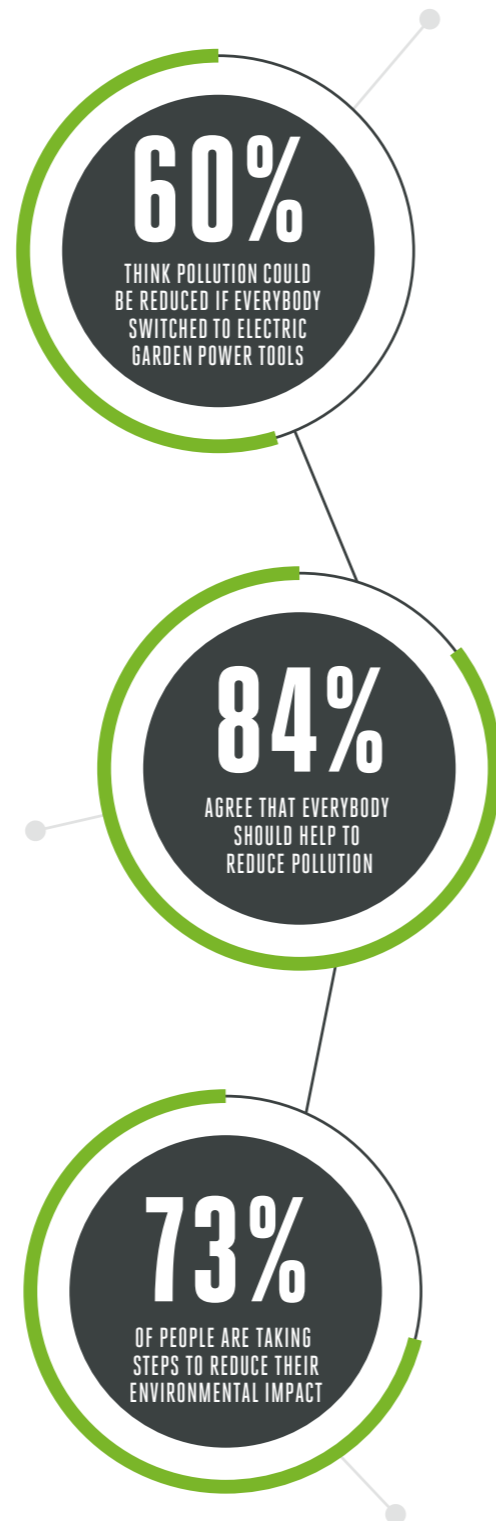

EVERYTHING YOU NEED TO KEEP YOU CUTTING, MOWING AND BLOWING

EGO POWER+ MULTI-TOOL BLADES, CHAINS, BARS AND TELESCOPIC POLE SAW

AE80800
Multi-tool edger blade for EA0800



AC1001
Pole saw chain for PSA1000 and PSX2500



AG1000
Pole saw bar for PSA1000 and PSX2500



AC89500
Multi-tool cultivator blade set for CTA9500



ARB2100
Paddle broom (pair) for BBA2100



ABS2100
Bristle brush (pair) for BBA2100



A0F3300
Olive Shaker fingers (10pcs) for OSA1000



AG1000Q
25cm Chainsaw Bar for PS1000E



AC1000Q
25cm Chainsaw Chain for PS1000E



EGO POWER+ MOWER BLADES AND ROLLERS

AB2001
Bagging blade for LM2010E, LM2010E-SP, LM2020E, LM2020E-SP [fitted as standard]



AB2101
52cm bagging blade for LM2100E-SP, LM2120E-SP [fitted as standard]



AB2102D-E
52cm dual bagging blade for LM2130E-SP (2 blade set) [fitted as standard]



AB5200
Bagging blade for ZT5200E-L



AB2000
Mulching blade for LM2000E, LM2010E, LM2010E-SP, LM2020E, LM2020E-SP



AB2100
52cm mulching blade for LM2100E-SP, LM2120E-SP



AB2100D-E
52cm dual mulching blade for LM2130E-SP (2 blade set)



AB1700
42cm mulching blade for LM1700E, LM1700E-SP



AB1900
47cm mulching blade for LM1900E, LM1900E-SP



AB1701
42cm bagging blade for LM1700E, LM1700E-SP [fitted as standard]



AB1901
47cm bagging blade for LM1900E, LM1900E-SP [fitted as standard]



AB4200
53cm standard blade (side discharge, mulching & bagging) for ZT4200E-L - single blade



AB4201
53cm high-lift blade (improved bagging) for ZT4200E-L - single blade



AMP4200
Mulching plug for ZT4200E-L



ABK4200-A
Bagging kit for ZT4200E-L



ABK5200-A
Bagging kit for ZT5200E-L



AR1700
42cm rear roller kit for LM1700E, LM1700E-SP



AR1900
47cm rear roller kit for LM1900E, LM1900E-SP



AR2100
52cm rear roller kit for LM2130E-SP



MULCHING KITS

ABP1700
Mulching kit (blade & mulching plug) for LM1700E, LM1700E-SP



ABP1900
Mulching kit (blade & mulching plug) for LM1900E, LM1900E-SP



ABP2100D-E
52cm mulching kit (mulching blade set & mulching plug) for LM2130E-SP



ABP5200
Mulching kit for ZT5200E-L



EGO POWER+ ADAPTOR

ADB1000
Adaptor for use with BH1000, BHX1000, BAX1300, BAX1500



ACA1000
For use with the EGO 550W Rapid Charger



EGO POWER+ LINE TRIMMER SPOOLS

AS3800
Spool w/o line for bump feed cutting head - BCX3800, STX3800



AS1301
Spool with 2.0mm round line for standard bump feed cutting head - ST1210E



AS1302
Spool with 2.0mm twist line for standard bump feed cutting head - ST1300E



AS1300
Spool with 2.4mm twist line for standard bump feed cutting head - ST1500E, BC1500E



EGO POWER+ TRIMMER LINES

AL2015T ◆
15m 2.0mm low-noise twist line (STRATUS)

AL2050T ◆
50m 2.0mm twist line - ST1300E and ST1400E-ST

AL2715T ◆
15m 2.7mm low-noise twist line [red/green] - STX3800, BCX3800

AL3012T ◆
12m 3.0mm low-noise twist line [yellow/green] - STX3800, BCX3800

AL2475T ◆
75m 2.4mm low-noise twist line [orange/green] - ALL 35cm & 38cm cutting diameter grass trimmers

AL2760T ◆
60m 2.7mm low-noise twist line [red/green] - STX3800, BCX3800

AL3050T ◆
50m 3.0mm low-noise twist line [yellow/green] - STX3800, BCX3800

AL2415R ●
15m 2.4mm round line [orange] - ALL 35cm & 38cm cutting diameter grass trimmers

AL2715R ●
15m 2.7mm round line [red] - STX3800, BCX3800

AL3012R ●
12m 3.0mm round line [yellow] - STX3800, BCX3800

AL2490R ●
90m 2.4mm round line [orange] - ALL 35cm & 38cm cutting diameter grass trimmers

AL2780R ●
80m 2.7mm round line [red] - STX3800, BCX3800

AL3060R ●
60m 3.0mm round line [yellow] - STX3800, BCX3800

AL2416P ◆
4 x 4.0m 2.4mm twisted line [black/orange] - ST1400E-ST, ST1510E

EGO POWER+ LINE TRIMMER HEADS

AH3800
Bump feed cutting head without line - STX3800, BCX3800



AH3810
ANY INSERT cutting head - ANTI-CLOCKWISE - STX3800, BCX3800, ST1530E, BC3800E, STA1500, BCA1200



AH1520
Powerload™ cutting head for ST1510E



AH1522
Powerload™ cutting head for ST1400E-ST



AH1530
ANY INSERT cutting head - CLOCKWISE - ST1500E-F, BC1500E-F



AH1600
Powerload™ cutting head for STA1600



AH1620
Line IQ™ cutting head for ST1610E-T



AH1531
ANY INSERT cutting head - ANTI-CLOCKWISE - ST1530E, BC3800E, STA1500



ABT3800
Bump feed button - AH3800



ABR2300
Replacement blades (pair) - ROTOCUT RTX2300, RTA2300



EGO POWER+ BRUSH CUTTER BLADE

ABB1203
3 point brush cutter blade - STX3800, BCX3800, ST1530E, BC3800E, BCA1200, STA1500



ABB0903P
Elastoblade Flexible trimming blade for - STX3800, BCX3800, ST1530E, BC3800E, BCA1200, STA1500



**EGO POWER+
HEDGE TRIMMER
TIP PROTECTOR**

ATP2000
Tip protector for
HTA2000, PTX5100



**EGO POWER+
GRASS SHEARS**

CCH0450E
12V charger for CHT2001E



CBA0240
2.0Ah 12V battery for CHT2001E



EGO POWER+ BAGS

BCS1000
Durable Chainsaw kit bag



BMH1000
Multi-tool
wheeled kit bag



CM001
Storage cover for lawnmowers



CRM001
Storage cover for Z6



**EGO POWER+
CHAINSAW CHAINS**

AC1201
30cm 90PX chain for CSX3000

AC1401
35cm 90PX chain for CS1400E

AC1601
40cm 90PX chain for CS1600E

AC1801
45cm 91PX chain for CS1800E



**EGO POWER+
CHAINSAW BARS**

AG1200
30cm guide bar for CSX3000

AG1400
35cm guide bar for CS1400E

AG1600
40cm guide bar for CS1600E

AG1800
45cm guide bar for CS1800E



**EGO POWER+
Z6 ZTR RIDE-ON MOWER**

AMG1000
Zero turn riding mower
on-board storage



AMS1000
Zero turn riding
mower sun shade



AMB1000
Zero turn riding mower
rear bumper bar



GUTTER CLEANING PACK

AGC1001
Gutter cleaning
pack and glasses
for LB5300E
and LB5800E



**EGO POWER+
WALL HOOK**

AWH1500
Wall mounted hanging frame
for CHX5500E & BAX batteries



**EGO POWER+
SNOW THROWER**

AKS2400D
Skid shoes (pair) - SNT2400E



ACT2400
Chute cleaning tool - SNT2400E



ADC2400
Drift cutters for SNT2400E



ARP2120
52cm Snow Blower
Rubber Paddle (PAIR)
for SN2120E-AP



ASS2120
52cm Snow Blower
Scraper Bar for SN2120E-AP



**EGO POWER+
SHOULDER STRAPS**

AP1500
Single-shoulder harness
with one hook - multi-tool,
LB5300E, LB5750E and
all grass trimmers
except BCX3800



**EGO POWER+
HARNESSES**

AP4800
Single-shoulder harness without
loop, two hook - LB4800E only



AFH1500
Frame and double-shoulder
harness with padded comfort
straps for BAX1500 and BHX1000



ACH1500
Cable routing clip for harness
BH1000, AFH1500



AP1500D
Double-shoulder harness with
guard pad for multi-tool &
all grass trimmers except BCX3800



AP1300
Replacement double-shoulder
comfort straps for BAX1300



AHP1500
Leg protector / line trimmer
attachment for AFH1500



AHP1300
Leg protector / line
trimmer harness
attachment for
AFH1300, BH1000



**EGO POWER+
PROTECTIVE CLOTHING**

GV001E
Multi-purpose synthetic work
gloves. Sizes from Small to
XX-Large available



GS001E
Essential clear safety glasses



GS002E
Essential grey safety glasses



GS003E
Essential yellow safety glasses



**EGO POWER+
BATTERY STORAGE**

BBOX2550
Transportation box that can
carry 5 portable batteries
of all EGO sizes. Can be
connected to BBOX3000



BBOX3000
Transportation box for
BAX1500 excluding harness.
Can be connected to BBOX2550



EGO POWER+ MULTI-TOOL ICONS

Switch tools quickly for each task	For comfort and versatility	Large cutting width for a fast and efficient cut
Cutting depth to suit any lawn edge	Lightweight and extremely strong	Wide cutting width for efficient tilling
Constantly adjustable speed to match the needs of the task	Two-speed motor adjustable for task and economy needs	Adjust handle without additional tools
Wide cutting swathe for faster, more efficient trimming	Wide cutting width for fast and effective trimming	Can be used with Rotocut
Ideally suited to the tool for the best cutting results	Precisely cut and sharpened for great results	Simple line feeding making work simple and efficient
Makes loading line quick and easy	Automatic line replacement in only 10 seconds	Enabling precise and clean cutting
Ideal length suited to the tool for best cutting results	Less vibration to tackle the toughest jobs	Smooth and fast cutting
Ideal for all cutting tasks	Prevents debris from being thrown, ideal in delicate areas	

EGO POWER+ MOWER ICONS

Cutting width to suit any size lawn	Variable speed to suit your walking pace	Light and manoeuvrable, while remaining durable
Tough and durable cutting deck	Motor adjusts to grass conditions, saving energy	Efficient grass collection bag
For convenient storage and easy cleaning	Prevents grass from leaving the collection bag	For use in low light areas
Allows grass to be cut and distributed back into the lawn	Creates desired striping pattern on the lawn	Year-round protection against dust, dirt and debris

EGO POWER+ RIDE-ON MOWER ICONS

Fully customisable to suit your ride	Variable speed	For full 360° turning
To maximise cutting width	Turn on the spot	For use in low light areas
Cutting width to suit any size lawn	Drive like a car	Year-round protection against dust, dirt and debris
Prevents grass from leaving the collection bag	Allows grass to be cut and distributed back into the lawn	Allows for grass collection
Protection on sunny days	Extra storage on your mower	Protection when reversing

EGO POWER+ LINE TRIMMER AND BRUSH CUTTER ICONS

Wide cutting swathe for faster, more efficient trimming	Wide cutting width for fast and effective trimming	Two-speed motor adjustable for task and economy needs
Constantly adjustable speed to match the needs of the task	Ideally suited to the tool for the best cutting results	Automatic line replacement in only 10 seconds
Simple line feeding making work simple and efficient	Fast and tool-free line reloading	Adjust handle without additional tools
Lightweight and extremely strong	Work all day in comfort	Can be used with Rotocut
Keep trimming for non-stop performance	Prevents debris from being thrown, ideal in delicate areas	Wide cutting width for fast and effective trimming
Extends for versatility	Makes loading line quick and easy	Work all day in comfort

EGO POWER+ HEDGE TRIMMER ICONS

Ideal length suited to the tool for best cutting results	Fast, precise grass trimming attachment	Enabling precise and clean cutting
Two-speed motor adjustable for task and economy needs	Precisely cut and sharpened for great results	Less vibration to tackle the toughest jobs
Rotating rear handle for greater comfort and versatility	Extends for versatility	For comfort and versatility
Constantly adjustable speed to match the needs of the task	Work all day in comfort	Work all day in comfort

EGO POWER+ CHAINSAW ICONS

Ideal for all cutting tasks	Smooth and fast cutting
Enhancing safety while in use	Auto chain tensioning
Metal bumper spikes	For use in low light areas
Alerts you when it's time to charge	Light indicates when oil levels are low
Work all day in comfort	Work all day in comfort

EGO POWER+ BLOWER AND SNOW THROWER ICONS

Increased power to clear large areas	Constantly adjustable speed to match the needs of the task	Variable speed to suit your walking pace
Work all day in comfort	Work all day in comfort	For use in low light areas
Enables snow thrower to clear snow quickly even in extreme conditions	Impressive clearing distances even in extreme conditions	Provides traction to the snow during use
Generous widths clear snow efficiently	High traction tyres and self propel system	Manoeuvre through snow and ice with ease



EGO WILL CONTINUE TO DELIVER INNOVATION
IN NEW PRODUCT DEVELOPMENT - AND CLEAN,
RELIABLE POWER FOR A GREENER FUTURE.



Your local dealer:



www.egopowerplus.com



All rights reserved. Neither this catalogue nor its text, images, illustrations or part thereof, may be reproduced, stored in a retrieval system, photocopied, recorded or transmitted in any form, whether electronic or otherwise, without our consent. To the best of our knowledge, all descriptions, images and illustrations contained in this catalogue are correct at the time of going to print. We cannot, however, be held liable for any inaccuracies of description, image or illustration and reserve the right to change specifications without notification.

©EGO 2023

01ENTCAT01-2300